

# NivoGuide® 8100

Two-wire 4 ... 20 mA/HART

Coax probe

TDR sensor for continuous level and interface measurement of liquids



---

Technical information / Instruction manual



Document ID: 61019





# Contents

<b>1</b>	<b>About this document</b> .....	<b>4</b>
1.1	Function .....	4
1.2	Target group .....	4
1.3	Symbols used.....	4
<b>2</b>	<b>For your safety</b> .....	<b>5</b>
2.1	Authorised personnel .....	5
2.2	Appropriate use.....	5
2.3	Warning about incorrect use.....	5
2.4	General safety instructions .....	5
2.5	EU conformity.....	6
2.6	NAMUR recommendations .....	6
2.7	Installation and operation in the USA and Canada .....	6
<b>3</b>	<b>Product description</b> .....	<b>7</b>
3.1	Configuration.....	7
3.2	Principle of operation.....	8
3.3	Packaging, transport and storage.....	10
3.4	Accessories and replacement parts .....	10
<b>4</b>	<b>Mounting</b> .....	<b>12</b>
4.1	General instructions .....	12
4.2	Mounting instructions .....	13
<b>5</b>	<b>Connecting to power supply</b> .....	<b>16</b>
5.1	Preparing the connection .....	16
5.2	Connecting.....	17
5.3	Wiring plan, single chamber housing.....	18
5.4	Wiring plan, double chamber housing .....	19
5.5	Switch-on phase.....	20
<b>6</b>	<b>Set up with the display and adjustment module</b> .....	<b>21</b>
6.1	Insert display and adjustment module .....	21
6.2	Adjustment system .....	22
6.3	Parameter adjustment - Quick setup .....	24
6.4	Parameter adjustment - Extended adjustment.....	24
6.5	Saving the parameterisation data .....	41
<b>7</b>	<b>Diagnostics and servicing</b> .....	<b>43</b>
7.1	Maintenance .....	43
7.2	Diagnosis memory .....	43
7.3	Status messages.....	43
7.4	Rectify faults.....	46
7.5	Exchanging the electronics module.....	49
7.6	How to proceed if a repair is necessary.....	50
<b>8</b>	<b>Dismount</b> .....	<b>51</b>
8.1	Dismounting steps.....	51
8.2	Disposal .....	51
<b>9</b>	<b>Supplement</b> .....	<b>52</b>
9.1	Technical data .....	52
9.2	Dimensions .....	62

---

9.3	Trademark .....	64
-----	-----------------	----

**Safety instructions for Ex areas**

Take note of the Ex specific safety instructions for Ex applications. These instructions are attached as documents to each instrument with Ex approval and are part of the operating instructions.

Editing status: 2019-02-05

# 1 About this document

## 1.1 Function

This operating instructions provides all the information you need for mounting, connection and setup as well as important instructions for maintenance, fault rectification, the exchange of parts and the safety of the user. Please read this information before putting the instrument into operation and keep this manual accessible in the immediate vicinity of the device.

## 1.2 Target group

This operating instructions manual is directed to trained personnel. The contents of this manual must be made available to the qualified personnel and implemented.

## 1.3 Symbols used



### Information, tip, note

This symbol indicates helpful additional information.



**Caution:** If this warning is ignored, faults or malfunctions can result.



**Warning:** If this warning is ignored, injury to persons and/or serious damage to the instrument can result.



**Danger:** If this warning is ignored, serious injury to persons and/or destruction of the instrument can result.



### Ex applications

This symbol indicates special instructions for Ex applications.



### List

The dot set in front indicates a list with no implied sequence.



### Action

This arrow indicates a single action.



### Sequence of actions

Numbers set in front indicate successive steps in a procedure.



### Battery disposal

This symbol indicates special information about the disposal of batteries and accumulators.

## 2 For your safety

### 2.1 Authorised personnel

All operations described in this documentation must be carried out only by trained, qualified personnel authorised by the plant operator.

During work on and with the device, the required personal protective equipment must always be worn.

### 2.2 Appropriate use

NivoGuide 8100 is a sensor for continuous level measurement.

You can find detailed information about the area of application in chapter "*Product description*".

Operational reliability is ensured only if the instrument is properly used according to the specifications in the operating instructions manual as well as possible supplementary instructions.

### 2.3 Warning about incorrect use

Inappropriate or incorrect use of this product can give rise to application-specific hazards, e.g. vessel overflow through incorrect mounting or adjustment. Damage to property and persons or environmental contamination can result. Also, the protective characteristics of the instrument can be impaired.

### 2.4 General safety instructions

This is a state-of-the-art instrument complying with all prevailing regulations and directives. The instrument must only be operated in a technically flawless and reliable condition. The operator is responsible for the trouble-free operation of the instrument. When measuring aggressive or corrosive media that can cause a dangerous situation if the instrument malfunctions, the operator has to implement suitable measures to make sure the instrument is functioning properly.

During the entire duration of use, the user is obliged to determine the compliance of the necessary occupational safety measures with the current valid rules and regulations and also take note of new regulations.

The safety instructions in this operating instructions manual, the national installation standards as well as the valid safety regulations and accident prevention rules must be observed by the user.

For safety and warranty reasons, any invasive work on the device beyond that described in the operating instructions manual may be carried out only by personnel authorised by the manufacturer. Arbitrary conversions or modifications are explicitly forbidden. For safety reasons, only the accessory specified by the manufacturer must be used.

To avoid any danger, the safety approval markings and safety tips on the device must also be observed and their meaning read in this operating instructions manual.

## 2.5 EU conformity

The device fulfils the legal requirements of the applicable EU directives. By affixing the CE marking, we confirm the conformity of the instrument with these directives.

## 2.6 NAMUR recommendations

NAMUR is the automation technology user association in the process industry in Germany. The published NAMUR recommendations are accepted as the standard in field instrumentation.

The device fulfils the requirements of the following NAMUR recommendations:

- NE 21 – Electromagnetic compatibility of equipment
- NE 43 – Signal level for fault information from measuring transducers
- NE 53 – Compatibility of field devices and display/adjustment components
- NE 107 – Self-monitoring and diagnosis of field devices

For further information see [www.namur.de](http://www.namur.de).

## 2.7 Installation and operation in the USA and Canada

This information is only valid for USA and Canada. Hence the following text is only available in the English language.

Installations in the US shall comply with the relevant requirements of the National Electrical Code (ANSI/NFPA 70).

Installations in Canada shall comply with the relevant requirements of the Canadian Electrical Code

A Class 2 power supply unit has to be used for the installation in the USA and Canada.

## 3 Product description

### 3.1 Configuration

#### Type label

The type label contains the most important data for identification and use of the instrument:

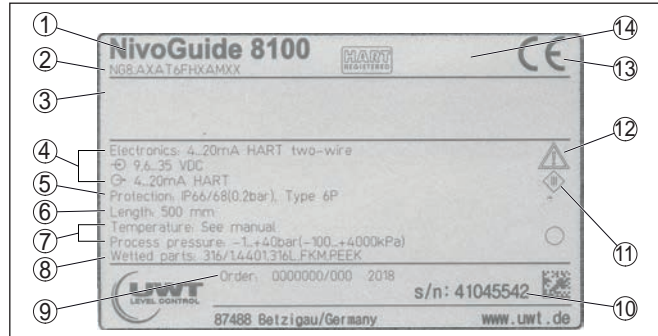

Fig. 1: Layout of the type label (example)

- 1 Instrument type
- 2 Product code
- 3 Approvals (option)
- 4 Power supply and signal output, electronics
- 5 Protection rating
- 6 Probe length (measurement accuracy optional)
- 7 Process and ambient temperature, process pressure
- 8 Material wetted parts
- 9 Order number
- 10 Serial number of the instrument
- 11 Symbol of the device protection class
- 12 ID numbers, instrument documentation
- 13 CE identification
- 14 Approval directives (optional)

#### Scope of this operating instructions

This operating instructions manual applies to the following instrument versions:

- Hardware from 1.0.0
- Software from 1.3.0
- Only for instrument versions without SIL qualification

#### Versions

The instrument and the electronics version can be determined via the product code on the type label as well as on the electronics.

- Standard electronics: Type FX80H.-

#### Scope of delivery

The scope of delivery encompasses:

- Sensor
- Optional accessory
- Documentation
  - Quick setup guide NivoGuide 8100
  - Instructions for optional instrument features
  - Ex-specific "Safety instructions" (with Ex versions)

- If necessary, further certificates



**Information:**

In this operating instructions manual, the optional instrument features are described. The respective scope of delivery results from the order specification.

**3.2 Principle of operation**

**Application area**

The NivoGuide 8100 is a level sensor with coax probe for continuous level or interface measurement, suitable for applications in liquids.

**Functional principle - level measurement**

High frequency microwave pulses are guided along a steel cable or a rod. Upon reaching the product surface, the microwave pulses are reflected. The running time is evaluated by the instrument and output as level.

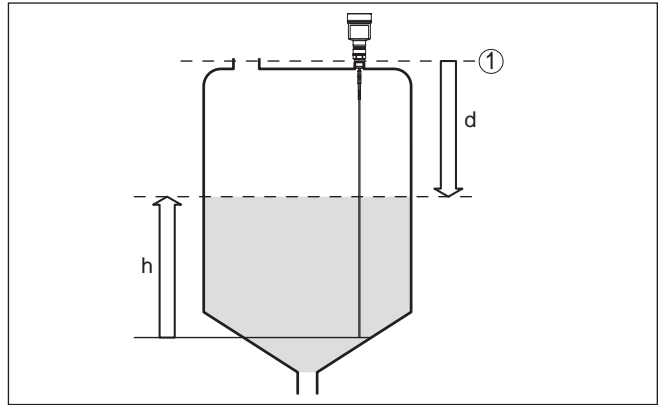

Fig. 2: Level measurement

- 1 Sensor reference plane (seal surface of the process fitting)
- d Distance to the level
- h Height - Level

**Functional principle - interface measurement**

High frequency microwave impulses are guided along a steel cable or rod. Upon reaching the product surface, a part of the microwave impulses is reflected. The other part passes through the upper product and is reflected by the interface. The running times to the two product layers are processed by the instrument.



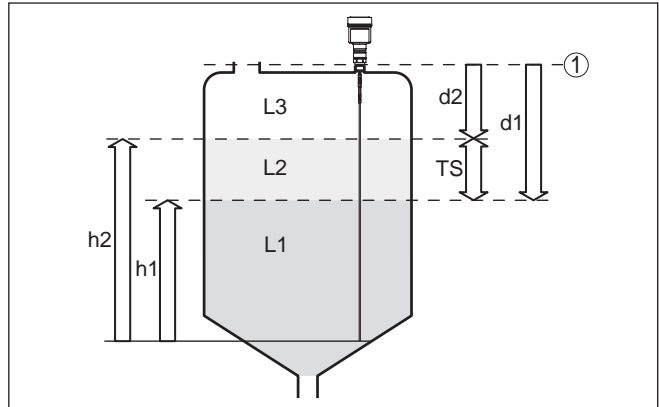

Fig. 3: Interface measurement

- 1 Sensor reference plane (seal surface of the process fitting)
- d1 Distance to the interface
- d2 Distance to the level
- TS Thickness of the upper medium ( $d1 - d2$ )
- h1 Height - Interface
- h2 Height - Level
- L1 Lower medium
- L2 Upper medium
- L3 Gas phase

### Prerequisites for interface measurement

#### Upper medium (L2)

- The upper medium must not be conductive
- The dielectric constant of the upper medium or the actual distance to the interface must be known (input required). Min. dielectric constant: 1.6.
- The composition of the upper medium must be stable, no varying products or mixtures
- The upper medium must be homogeneous, no stratifications within the medium
- Min. thickness of the upper medium 50 mm (1.97 in)
- Clear separation from the lower medium, emulsion phase or detritus layer max. 50 mm (1.97 in)
- If possible, no foam on the surface

#### Lower medium (L1)

- The dielectric constant must be 10 higher than the dielectric constant of the upper medium, preferably electrically conductive. Example: upper medium dielectric constant 2, lower medium at least dielectric constant 12.

#### Gas phase (L3)

- Air or gas mixture
- Gas phase - dependent on the application, gas phase does not always exist ( $d2 = 0$ )

<b>Output signal</b>	<p>The instrument is always preset to the application "<i>Level measurement</i>".</p> <p>For the interface measurement, you can select the requested output signal with the setup.</p>
<b>3.3 Packaging, transport and storage</b>	
<b>Packaging</b>	<p>Your instrument was protected by packaging during transport. Its capacity to handle normal loads during transport is assured by a test based on ISO 4180.</p> <p>The packaging of standard instruments consists of environment-friendly, recyclable cardboard. For special versions, PE foam or PE foil is also used. Dispose of the packaging material via specialised recycling companies.</p>
<b>Transport</b>	<p>Transport must be carried out in due consideration of the notes on the transport packaging. Nonobservance of these instructions can cause damage to the device.</p>
<b>Transport inspection</b>	<p>The delivery must be checked for completeness and possible transit damage immediately at receipt. Ascertained transit damage or concealed defects must be appropriately dealt with.</p>
<b>Storage</b>	<p>Up to the time of installation, the packages must be left closed and stored according to the orientation and storage markings on the outside.</p> <p>Unless otherwise indicated, the packages must be stored only under the following conditions:</p> <ul style="list-style-type: none"> <li>● Not in the open</li> <li>● Dry and dust free</li> <li>● Not exposed to corrosive media</li> <li>● Protected against solar radiation</li> <li>● Avoiding mechanical shock and vibration</li> </ul>
<b>Storage and transport temperature</b>	<ul style="list-style-type: none"> <li>● Storage and transport temperature see chapter "<i>Supplement - Technical data - Ambient conditions</i>"</li> <li>● Relative humidity 20 ... 85 %</li> </ul>
<b>Lifting and carrying</b>	<p>With instrument weights of more than 18 kg (39.68 lbs) suitable and approved equipment must be used for lifting and carrying.</p>
<b>3.4 Accessories and replacement parts</b>	
<b>Display and adjustment module</b>	<p>The display and adjustment module is used for measured value indication, adjustment and diagnosis. It can be inserted into the sensor and removed at any time.</p> <p>You can find further information in the operating instructions "<i>Display and adjustment module</i>".</p>
<b>Flanges</b>	<p>Screwed flanges are available in different versions according to the following standards: DIN 2501, EN 1092-1, BS 10, ASME B 16.5, JIS B 2210-1984, GOST 12821-80.</p>

You can find additional information in the supplementary instructions manual "*Flanges according to DIN-EN-ASME-JIS*".

**Electronics module**

The electronics module NivoGuide is a replacement part for GWR sensors of the NivoGuide series.

You can find further information in the operating instructions manual "*Electronics module NivoGuide*".

## 4 Mounting

### 4.1 General instructions

#### Screwing in

On devices with a threaded fitting, the hexagon on the process fitting must be tightened with a suitable wrench.

See chapter "*Dimensions*" for wrench size.



#### Warning:

The housing or the electrical connection may not be used for screwing in! Tightening can cause damage, e. g. to the rotation mechanism of the housing.

#### Protection against moisture

Protect your instrument against moisture ingress through the following measures:

- Use a suitable connection cable (see chapter "*Connecting to power supply*")
- Tighten the cable gland or plug connector
- When mounting horizontally, turn the housing so that the cable gland or plug connector point downward
- Lead the connection cable downward in front of the cable entry or plug connector.

This applies mainly to outdoor installations, in areas where high humidity is expected (e.g. through cleaning processes) and on cooled or heated vessels.

To maintain the housing protection, make sure that the housing lid is closed during operation and locked, if necessary.

Make sure that the degree of contamination specified in chapter "*Technical data*" meets the existing ambient conditions.

#### Cable glands

##### Metric threads

In the case of instrument housings with metric thread, the cable glands are screwed in at the factory. They are sealed with plastic plugs as transport protection.

You have to remove these plugs before electrical connection.

##### NPT thread

In the case of instrument housings with self-sealing NPT threads, it is not possible to have the cable entries screwed in at the factory. The free openings for the cable glands are therefore covered with red dust protection caps as transport protection. The dust protection caps do not provide sufficient protection against moisture.

Prior to setup you have to replace these protective caps with approved cable glands or close the openings with suitable blind plugs.

#### Suitability for the process conditions

Make sure before mounting that all parts of the instrument exposed to the process are suitable for the existing process conditions.

These are mainly:

- Active measuring component
- Process fitting
- Process seal

Process conditions in particular are:

- Process pressure
- Process temperature
- Chemical properties of the medium
- Abrasion and mechanical influences

You can find detailed information on the process conditions in chapter "Technical data" as well as on the type label.

#### Suitability for the ambient conditions

The instrument is suitable for standard and extended ambient conditions acc. to IEC/EN 61010-1.

#### Installation position

### 4.2 Mounting instructions

In vessels with conical bottom it can be advantageous to mount the sensor in the center of the vessel, as measurement is then possible nearly down to the lowest point of the bottom. Keep in mind that measurement all the way down to the tip of the probe may not be possible. The exact value of the min. distance (lower dead band) is stated in chapter "Technical data".

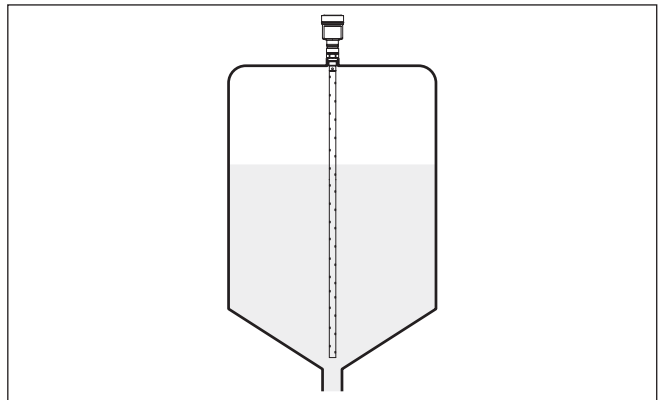

Fig. 4: Vessel with conical bottom

#### Welding work

Before beginning the welding work, remove the electronics module from the sensor. By doing this, you avoid damage to the electronics through inductive coupling.

#### Inflowing medium

Do not mount the instruments in or above the filling stream. Make sure that you detect the product surface, not the inflowing product.

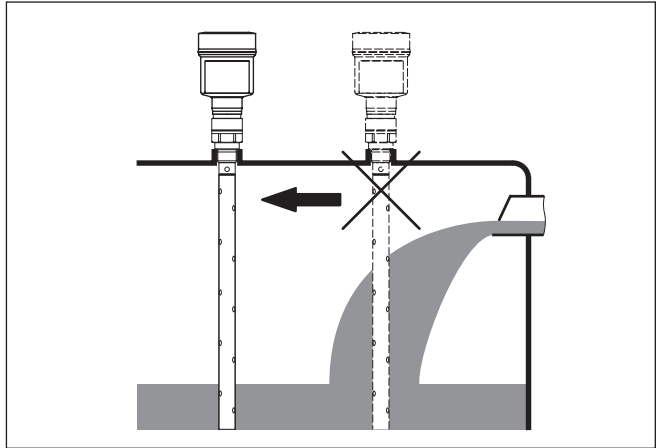

Fig. 5: Mounting of the sensor with inflowing medium

### Measuring range

The reference plane for the measuring range of the sensors is the sealing surface of the thread or flange.

Keep in mind that a min. distance must be maintained below the reference plane and possibly also at the end of the probe - measurement in these areas is not possible (dead band). These dead bands are listed in chapter "*Technical data*". Keep in mind for the adjustment that the default setting for the measuring range refers to water.

### Pressure

The process fitting must be sealed if there is gauge or low pressure in the vessel. Before use, check if the seal material is resistant against the measured product and the process temperature.

The max. permissible pressure is specified in chapter "*Technical data*" or on the type label of the sensor.

### Fasten

If there is a risk of the coaxial probe touching the vessel wall during operation due to product movements or agitators, etc., the measuring probe should be securely fixed.

Avoid undefined vessel connections, i.e. the connection must be either grounded reliably or isolated reliably. Any undefined change of this condition can lead to measurement errors.

If there is a danger of the coaxial probe touching the vessel wall, then the probe must be fastened at the bottom end.

Keep in mind that measurement is not possible below the fastening point.

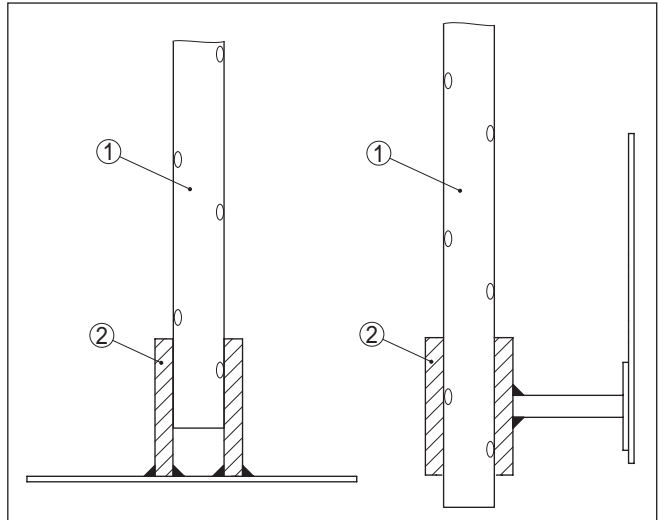

*Fig. 6: Fasten the probe*

- 1 Coax probe
- 2 Retaining sleeve

## 5 Connecting to power supply

### 5.1 Preparing the connection

#### Safety instructions

Always keep in mind the following safety instructions:

- Carry out electrical connection by trained, qualified personnel authorised by the plant operator
- If overvoltage surges are expected, overvoltage arresters should be installed



#### Warning:

Connect only in the complete absence of line voltage.

#### Voltage supply

Power supply and current signal are carried on the same two-wire cable. The operating voltage can differ depending on the instrument version.

The data for power supply are specified in chapter "*Technical data*".

Provide a reliable separation between the supply circuit and the mains circuits according to DIN EN 61140 VDE 0140-1.

Power the instrument via an energy-limited circuit acc. to IEC 61010-1, e.g. via Class 2 power supply unit.

Keep in mind the following additional factors that influence the operating voltage:

- Lower output voltage of the power supply unit under nominal load (e.g. with a sensor current of 20.5 mA or 22 mA in case of fault)
- Influence of additional instruments in the circuit (see load values in chapter "*Technical data*")

#### Connection cable

The instrument is connected with standard two-wire cable without screen. If electromagnetic interference is expected which is above the test values of EN 61326-1 for industrial areas, screened cable should be used.

Use cable with round cross section for instruments with housing and cable gland. Use a cable gland suitable for the cable diameter to ensure the seal effect of the cable gland (IP protection rating).

We generally recommend the use of shielded cable for HART multidrop mode.

#### Cable glands

##### Metric threads

In the case of instrument housings with metric thread, the cable glands are screwed in at the factory. They are sealed with plastic plugs as transport protection.

You have to remove these plugs before electrical connection.

##### NPT thread

In the case of instrument housings with self-sealing NPT threads, it is not possible to have the cable entries screwed in at the factory. The free openings for the cable glands are therefore covered with red dust protection caps as transport protection.



Prior to setup you have to replace these protective caps with approved cable glands or close the openings with suitable blind plugs. On plastic housings, the NPT cable gland or the Conduit steel tube must be screwed into the threaded insert without grease. Max. torque for all housings, see chapter "*Technical data*".

### Cable screening and grounding

If screened cable is required, we recommend connecting the cable screening on both ends to ground potential. In the sensor, the cable screening must be connected directly to the internal ground terminal. The ground terminal on the outside of the housing must be connected to the ground potential (low impedance).



In Ex systems, the grounding is carried out according to the installation regulations.

In electroplating plants as well as plants for cathodic corrosion protection it must be taken into account that significant potential differences exist. This can lead to unacceptably high currents in the cable screen if it is grounded at both ends.



#### Information:

The metallic parts of the instrument (process fitting, sensor, concentric tube, etc.) are connected with the internal and external ground terminal on the housing. This connection exists either directly via the conductive metallic parts or, in case of instruments with external electronics, via the screen of the special connection cable.

You can find specifications on the potential connections inside the instrument in chapter "*Technical data*".

## 5.2 Connecting

### Connection technology

The voltage supply and signal output are connected via the spring-loaded terminals in the housing.

Connection to the display and adjustment module or to the interface adapter is carried out via contact pins in the housing.



#### Information:

The terminal block is pluggable and can be removed from the electronics. To do this, lift the terminal block with a small screwdriver and pull it out. When reinserting the terminal block, you should hear it snap in.

### Connection procedure

Proceed as follows:

1. Unscrew the housing lid
2. If a display and adjustment module is installed, remove it by turning it slightly to the left
3. Loosen compression nut of the cable gland and remove blind plug
4. Remove approx. 10 cm (4 in) of the cable mantle, strip approx. 1 cm (0.4 in) of insulation from the ends of the individual wires
5. Insert the cable into the sensor through the cable entry

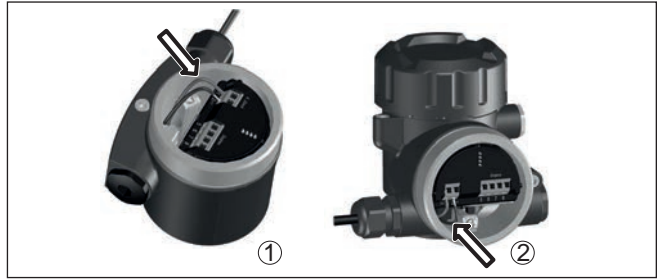

Fig. 7: Connection steps 5 and 6

- 1 Single chamber housing
- 2 Double chamber housing

6. Insert the wire ends into the terminals according to the wiring plan



#### Information:

Solid cores as well as flexible cores with wire end sleeves are inserted directly into the terminal openings. In case of flexible cores without end sleeves, press the terminal from above with a small screwdriver, the terminal opening is then free. When the screwdriver is released, the terminal closes again.

You can find further information on the max. wire cross-section under "*Technical data - Electromechanical data*".

7. Check the hold of the wires in the terminals by lightly pulling on them
8. Connect the screen to the internal ground terminal, connect the external ground terminal to potential equalisation
9. Tighten the compression nut of the cable entry gland. The seal ring must completely encircle the cable
10. Reinsert the display and adjustment module, if one was installed
11. Screw the housing lid back on

The electrical connection is finished.

### 5.3 Wiring plan, single chamber housing



The following illustration applies to the non-Ex, Ex-ia and Ex-d-ia version.

**Electronics and connection compartment**

Fig. 8: Electronics and connection compartment - single chamber housing

- 1 Voltage supply, signal output
- 2 For display and adjustment module or interface adapter
- 3 For external display and adjustment unit
- 4 Ground terminal for connection of the cable screening

**5.4 Wiring plan, double chamber housing**

The following illustrations apply to the non-Ex as well as to the Ex-ia version.

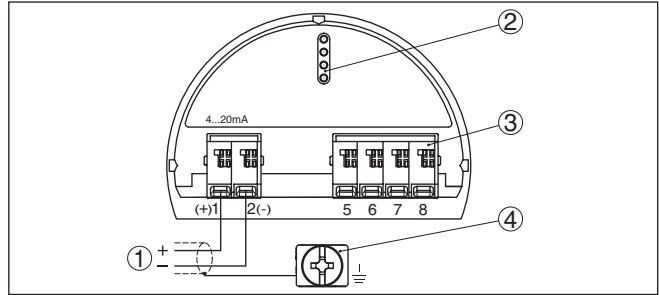
**Electronics compartment**

Fig. 9: Electronics compartment - double chamber housing

- 1 Internal connection to the connection compartment
- 2 For display and adjustment module or interface adapter

### Connection compartment

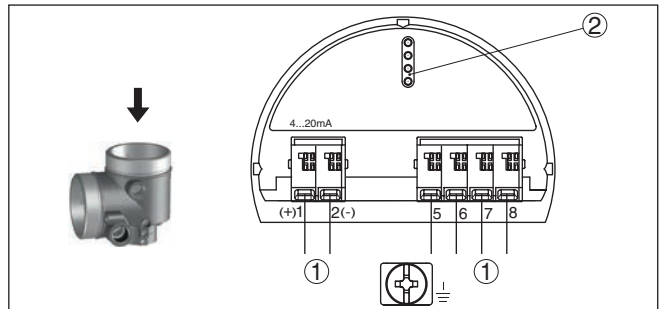
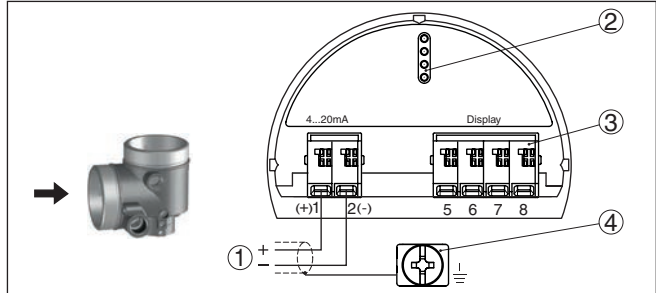

Fig. 10: Connection compartment - double chamber housing

- 1 Voltage supply, signal output
- 2 For display and adjustment module or interface adapter
- 3 For external display and adjustment unit
- 4 Ground terminal for connection of the cable screening

### 5.5 Switch-on phase

After connecting the instrument to voltage supply or after a voltage recurrence, the instrument carries out a self-check for approx. 30 s:

- Internal check of the electronics
- Indication of the instrument type, hardware and software version, measurement loop name on the display
- Indication of the status message "*F 105 Determine measured value*" on the display
- The output signal jumps to the set fault current

As soon as a plausible measured value is found, the corresponding current is output to the signal cable. The value corresponds to the actual level as well as the settings already carried out, e.g. factory setting.

## 6 Set up with the display and adjustment module

### 6.1 Insert display and adjustment module

The display and adjustment module can be inserted into the sensor and removed again at any time. You can choose any one of four different positions - each displaced by 90°. It is not necessary to interrupt the power supply.

Proceed as follows:

1. Unscrew the housing lid
2. Place the display and adjustment module on the electronics in the desired position and turn it to the right until it snaps in.
3. Screw housing lid with inspection window tightly back on

Disassembly is carried out in reverse order.

The display and adjustment module is powered by the sensor, an additional connection is not necessary.



Fig. 11: Installing the display and adjustment module in the electronics compartment of the single chamber housing



Fig. 12: Installing the display and adjustment module in the double chamber housing

- 1 In the electronics compartment
- 2 In the connection compartment



**Note:**

If you intend to retrofit the instrument with a display and adjustment module for continuous measured value indication, a higher lid with an inspection glass is required.

**6.2 Adjustment system**

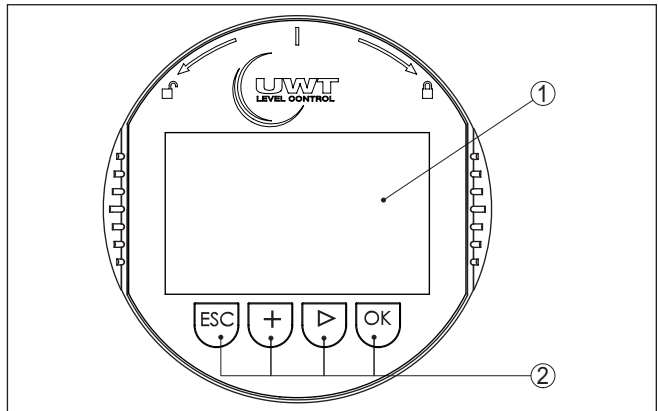

Fig. 13: Display and adjustment elements

- 1 LC display
- 2 Adjustment keys

**Key functions**

- [OK] key:

- Move to the menu overview
- Confirm selected menu
- Edit parameter
- Save value
- **[<->]** key:
  - Change measured value presentation
  - Select list entry
  - Select editing position
- **[+]** key:
  - Change value of the parameter
- **[ESC]** key:
  - Interrupt input
  - Jump to next higher menu

## Adjustment system

The sensor is operated via the four keys of the display and adjustment module. The individual menu items are shown on the LC display. You can find the function of the individual keys in the previous illustration.

When the **[+]** and **[<->]** keys are pressed quickly, the edited value, or the cursor, changes one value or position at a time. If the key is pressed longer than 1 s, the value or position changes continuously.

When the **[OK]** and **[ESC]** keys are pressed simultaneously for more than 5 s, the display returns to the main menu. The menu language is then switched over to "English".

Approx. 60 minutes after the last pressing of a key, an automatic reset to measured value indication is triggered. Any values not confirmed with **[OK]** will not be saved.

## Switch-on phase

After switching on, the NivoGuide 8100 carries out a short self-test where the device software is checked.

The output signal transmits a fault signal during the switch-on phase.

The following information is displayed on the display and adjustment module during the startup procedure:

- Instrument type
- Device name
- Software version (SW-Ver)
- Hardware version (HW-Ver)

## Measured value indication

With the **[<->]** key you can move between three different indication modes.

In the first view, the selected measured value is displayed in large digits.

In the second view, the selected measured value and a corresponding bar graph presentation are displayed.

In the third view, the selected measured value as well as a second selectable value, e.g. the temperature, are displayed.



### 6.3 Parameter adjustment - Quick setup

#### Quick setup

To quickly and easily adapt the sensor to the application, select the menu item "Quick setup" in the start graphic on the display and adjustment module.

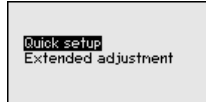

The following steps for the quick setup can be reached also in the "Extended adjustment".

- Instrument address
- Measurement loop name
- Medium type (optional)
- Application
- Max. adjustment
- Min. adjustment
- False signal suppression

You can find the description of the individual menu items in the following chapter "Parameter adjustment - Extended adjustment".

### 6.4 Parameter adjustment - Extended adjustment

For technically demanding measuring points, you can carry out extended settings in "Extended adjustment".

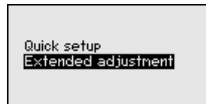

#### Main menu

The main menu is divided into five sections with the following functions:

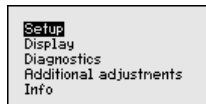

**Setup:** Settings, e.g. measurement loop name, medium, vessel, adjustment, signal output, device unit, false signal suppression, linearization curve

**Display:** Settings, e.g., for language, measured value display, lighting

**Diagnosis:** Information, e.g. on instrument status, pointer, measurement reliability, simulation, echo curve

**Additional adjustments:** Reset, date/time, reset, copy function



**Info:** Instrument name, hardware and software version, date of manufacture, instrument features



**Note:**

For optimum adjustment of the measuring point, the individual sub-menu items in the main menu item "Setup" should be selected one after the other and provided with the correct parameters. If possible, go through the items in the given sequence.

The procedure is described below.

The following submenu points are available:

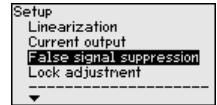
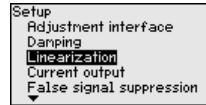
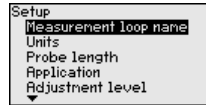

The submenu points are described below.

**Setup - Measurement loop name**

Here you can assign a suitable measurement loop name. Push the "OK" key to start the editing. With the "+" key you change the sign and with the "->" key you jump to the next position.

You can enter names with max. 19 characters. The character set comprises:

- Capital letters from A ... Z
- Numbers from 0 ... 9
- Special characters + - / \_ blanks

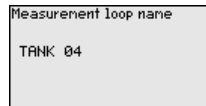

**Setup - Units**

In this menu item you select the distance unit and the temperature unit.

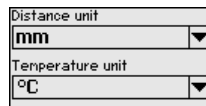

For the distance units you can choose between m, mm and ft and for the temperature units °C, °F and K.

**Setup - Probe length**

In this menu item you can enter the probe length or have the length determined automatically by the sensor system.

When choosing "Yes", then the probe length will be determined automatically. When choosing "No", you can enter the probe length manually.

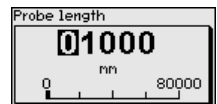
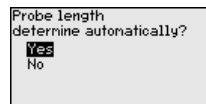
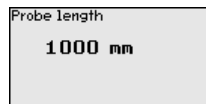

**Setup - Application - Type of medium**

Coax probes can be only used in liquids. In this menu item, the fixed adjusted medium type "Liquid" is displayed.

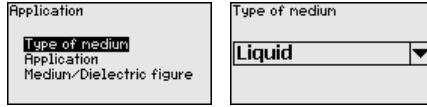

**Setup - Application - Application**

In this menu item, you can select the application. You can choose between level measurement and interface measurement. You can also choose between measurement in a vessel or in a bypass or standpipe.



**Note:**

The selection of the application has a considerable influence on all other menu items. Keep in mind that as you continue with the parameter adjustment, individual menu items are only optionally available.

You have the option of choosing the demonstration mode. This mode is only suitable for test and demonstration purposes. In this mode, the sensor ignores the parameters of the application and reacts immediately to any change.

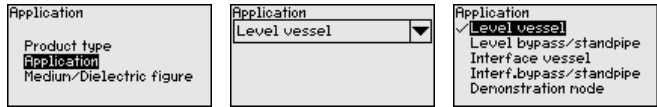

**Setup - Application - Medium, dielectric constant**

In this menu item, you can define the type of medium (product).

This menu item is only available if you have selected level measurement under the menu item "Application".

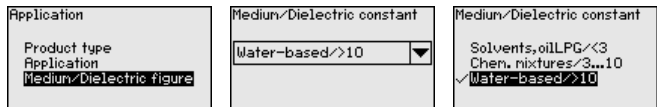

You can choose between the following medium types:

Dielectric constant	Type of medium	Examples
> 10	Water-based liquids	Acids, alcalis, water
3 ... 10	Chemical mixtures	Chlorobenzene, nitro lacquer, aniline, isocyanate, chloroform
< 3	Hydrocarbons	Solvents, oils, liquid gas

**Setup - Application - Gas phase**

This menu item is only available, if you have chosen interface measurement under the menu item "Application". In this menu item you can enter if there is a superimposed gas phase in your application.

Only set the function to "Yes", if the gas phase is permanently present.

Application
Product type
Application
<b>Gas phase</b>
Dielectric figure

Superimposed gas phase present?
<b>Yes</b>

Superimposed gas phase present?
No
<input checked="" type="checkbox"/> <b>Yes</b>

### Setup - Application - Dielectric constant

This menu item is only available if you have selected interface measurement under the menu item "Application". In this menu item you can enter the dielectric constant of the upper medium.

Application
Product type
Application
Gas phase
<b>Dielectric figure</b>

Dielectric figure upper medium
<b>2.000</b>

Dielectric constant
<b>Enter</b>
Calculate

You can directly enter the dielectric constant of the upper medium or have the value determined by the instrument.

If you want the dielectric constant to be determined by the instrument, you have to enter the measured or known distance to the interface.

Dielectric constant
<b>002.0</b>
1.0 100.0

Distance to the interface
<b>00000</b>
0 mm 99999

### Setup - Max. adjustment Level

In this menu item you can enter the max. adjustment for the level. With interface measurement this is the maximum total level.

Adjustment level
<b>Max. adjustment level</b>
Min. adjustment level

Max. adjustment level
<b>100.00 %</b>
≅ <b>50 mm</b>
726 mm



Adjust the requested percentage value with **[+]** and store with **[OK]**.

Max. adjustment level
<b>+100.00</b>
-10.00 % 110.00

Enter the appropriate distance value in m (corresponding to the percentage value) for the full vessel. The distance refers to the sensor reference plane (seal surface of the process fitting). Keep in mind that the max. level must lie below the dead band.

Max. adjustment level
<b>00050</b>
0 mm 80000

### Setup - Min. adjustment Level

In this menu item you can enter the min. adjustment for the level. With interface measurement this is the minimum total level.

Adjustment level
<b>Max. adjustment level</b>
<b>Min. adjustment level</b>

Min. adjustment level
<b>0.00 %</b>
≅ <b>850 mm</b>
726 mm



Adjust the requested percentage value with **[+]** and store with **[OK]**.

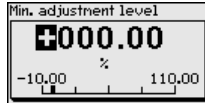

Enter the suitable distance value in m for the empty vessel (e.g. distance from the flange to the probe end) corresponding to the percentage value. The distance refers to the sensor reference plane (seal surface of the process fitting).

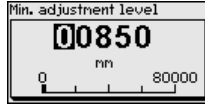

**Setup - Max. adjustment - Interface**

This menu item is only available if you have selected interface measurement under the menu item "Application".

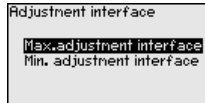

Enter the requested percentage value for the max. adjustment.

As an alternative, you have the possibility taking over the adjustment of the level measurement also for the interface.

Enter the respective distance value in m for the surface of the upper medium corresponding to the percentage value.

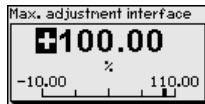

**Setup - Min. adjustment - Interface**

This menu item is only available if you have selected interface measurement under the menu item "Application".

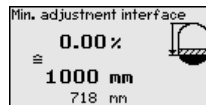
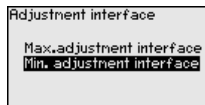

Enter the requested percentage value for the min. adjustment (interface).

Enter the respective distance value in m for the interface corresponding to the percentage value of the interface.

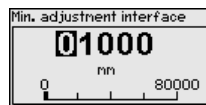
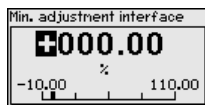

**Setup - Damping**

To damp process-dependent measured value fluctuations, set an integration time of 0 ... 999 s in this menu item.

If you have selected interface measurement under the menu item "Application", you can adjust the damping for the level and the interface separately.

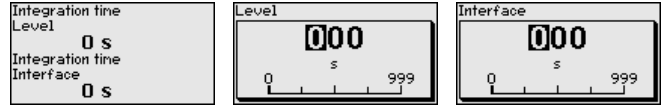

The default setting is a damping of 0 s.

## Setup - Linearisation

A linearisation is necessary for all vessels in which the vessel volume does not increase linearly with the level - e.g. a horizontal cylindrical or spherical tank, when the indication or output of the volume is required. Corresponding linearisation curves are preprogrammed for these vessels. They represent the correlation between the level percentage and vessel volume.

The linearisation applies to the measured value indication and the current output. By activating the appropriate curve, the volume percentage of the vessel is displayed correctly. If the volume should not be displayed in percent but e.g. in l or kg, a scaling can also be set in the menu item "Display".

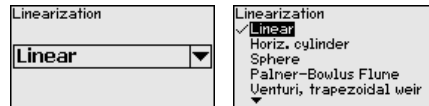

### Warning:

If a linearisation curve is selected, the measuring signal is no longer necessarily linear to the filling height. This must be considered by the user especially when setting the switching point on the limit signal transmitter.

In the following, you have to enter the values for your vessel, for example the vessel height and the socket correction.

For non-linear vessel forms, enter the vessel height and the socket correction.

For the vessel height, you have to enter the total height of the vessel.

For the socket correction you have to enter the height of the socket above the upper edge of the vessel. If the socket is lower than the upper edge of the vessel, this value can also be negative.

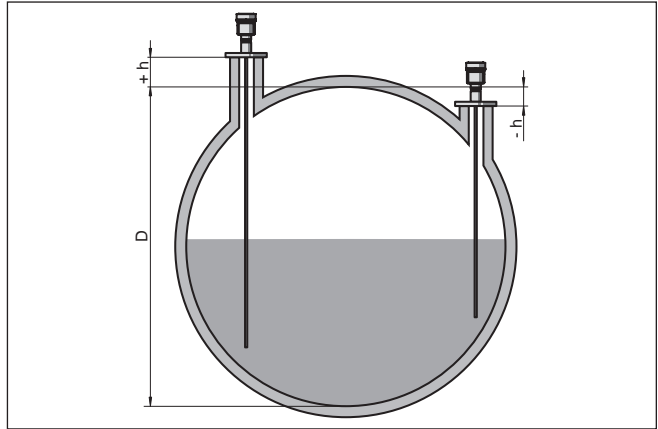
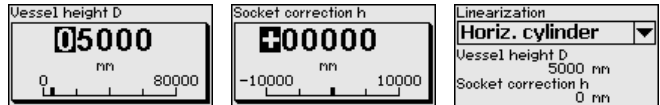

Fig. 14: Vessel height and socket correction value

*D* Vessel height

*+h* Positive socket correction value

*-h* Negative socket correction value



**Setup - Current output, mode**

In the menu item "Current output mode" you determine the output characteristics and reaction of the current output in case of fault.

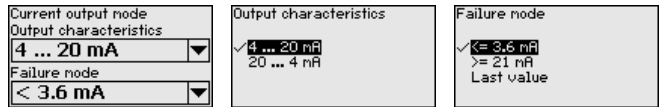

The default setting is output characteristics 4 ... 20 mA, fault mode < 3.6 mA.

**Setup - Current output Min./Max.**

In the menu item "Current output Min./Max.", you determine the reaction of the current output during operation.

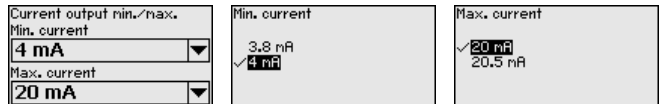

The default setting is min. current 3.8 mA and max. current 20.5 mA.

**Setup - False signal suppression**

The following circumstances cause interfering reflections and can influence the measurement:

- High mounting sockets
- Vessel internals such as struts



**Note:**

A false signal suppression detects, marks and saves these false signals so that they are no longer taken into account for the level and interface measurement. We generally recommend carrying out a false signal suppression to achieve the best possible accuracy. This should be done with the lowest possible level so that all potential interfering reflections can be detected.

Proceed as follows:

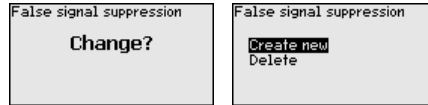

Select first if the probe is covered or uncovered.

If the probe is covered, enter the actual distance from the sensor to the product surface.

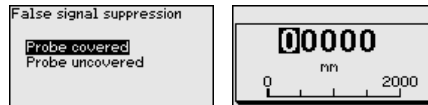

All interfering signals in this section are detected by the sensor and stored.

Keep in mind that with covered probe only false signals in the uncovered area of the probe are detected.



**Note:**

Check the distance to the product surface, because if an incorrect (too large) value is entered, the existing level will be saved as a false signal. The level would then no longer be detectable in this area.

If a false signal suppression has already been created in the sensor, the following menu window appears when selecting "False signal suppression":

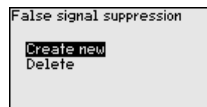

The instrument carries out an automatic false signal suppression as soon as the probe is uncovered. The false signal suppression is always updated.

The menu item "Delete" is used to completely delete an already created false signal suppression. This is useful if the saved false signal suppression no longer matches the metrological conditions in the vessel.

In the menu item "Lock/unlock adjustment", you can protect the sensor parameters against unauthorized or inadvertent modification. The PIN is activated/deactivated permanently.

With active PIN, only the following adjustment functions are possible without entering a PIN:

- Select menu items and show data
- Read data from the sensor into the display and adjustment module

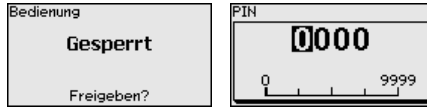

**Caution:**

When the PIN is active, adjustment via PACTware/DTM as well as other systems is also blocked.

In delivery status, the PIN is **0000**.

Call our service department if you have modified and forgotten the PIN.

**Display**

In the main menu point "*Display*", the individual submenu points should be selected one after the other and provided with the correct parameters to ensure the optimum adjustment of the display options. The procedure is described in the following.

The following submenu points are available:

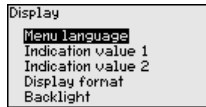

The submenu points are described below.

**Display - Menu language**

This menu item enables the setting of the requested national language.

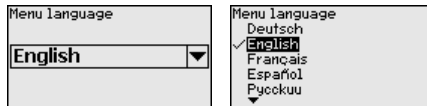

In delivery status, the sensor is set to English.

**Display - Displayed value 1**

In this menu item, you define the indication of the measured value on the display. You can display two different measured values. In this menu item, you define measured value 1.

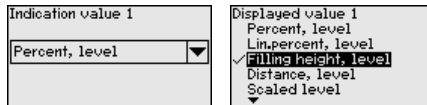

The default setting for the displayed value 1 is "*Filling height Level*".

**Display - Displayed value 2**

In this menu item, you define the indication of the measured value on the display. You can display two different measured values. In this menu item, you define measured value 2.



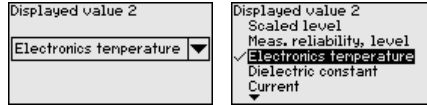

The default setting for the displayed value 2 is the electronics temperature.

### Display - Display format

In this menu item, you define the display format of the measured value on the display. You can define different display formats for the two measured values.

You can thus define the number of decimal positions the measured value is displayed with.

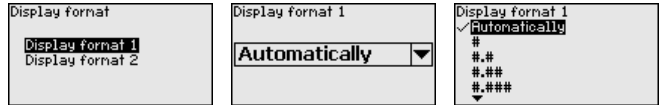

The default setting for the display format is "Automatic".

### Display - Backlight

The integrated background lighting can be switched off via the adjustment menu. The function depends on the strength of the supply voltage, see "Technical data".

To maintain the function of the device, the lighting is temporarily switched off if the power supply is insufficient.



In delivery status, the lighting is switched on.

### Diagnostics - Device status

In this menu item, the device status is displayed.

When the instrument displays a failure message, you can here get detailed information on the failure reason.

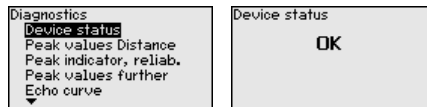

### Diagnostics - Peak values, Distance

The respective min. and max. measured value is saved in the sensor. The two values are displayed in the menu item "Peak values, distance".

If you have selected interface measurement under the menu item "Setup - Application", the peak values of the interface measurement are displayed in addition to the peak values of the level measurement.

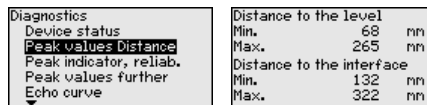

In another window you can carry out a reset of the two peak values separately.

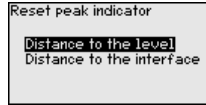

**Diagnostics - Peak values measurement reliability**

The respective min. and max. measured values are saved in the sensor. The two values are displayed in the menu item "Peak values, measurement reliability".

The measurement can be influenced by the process conditions. In this menu item, the measurement reliability of the level measurement is displayed in mV. The higher the value, the more reliable the measurement.

If you have selected interface measurement under the menu item "Setup - Application", the peak values of the interface measurement are displayed in addition to the peak values of the level measurement.

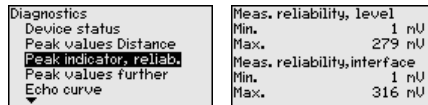

In another window you can carry out a reset of the two peak values separately.

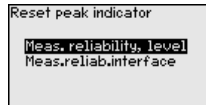

**Diagnostics - Peak values, Additional**

The respective min. and max. measured values are saved in the sensor. The values are displayed in the menu item "Peak values Additional".

This menu item displays the peak values of the electronics temperature as well as the dielectric constant.

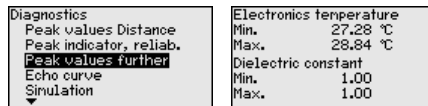

In another window you can carry out a reset of the two peak values separately.

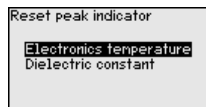

**Information:**

If one of the display values flashes, there is actually no valid value available.

## Diagnostics - Echo curve

The menu item "Echo curve" shows the signal strength of the echoes over the measuring range in V. The signal strength enables an evaluation of the quality of the measurement.

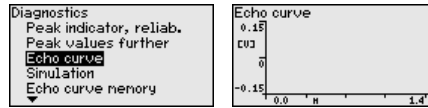

With the following functions you can zoom part sections of the echo curve.

- "X-Zoom": Zoom function for the meas. distance
- "Y-Zoom": 1, 2, 5 and 10x signal magnification in "V"
- "Unzoom": Reset the presentation to the nominal measuring range without magnification

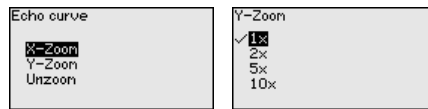

## Diagnosis - Simulation

In this menu item you can simulate measured values via the current output. This allows the signal path to be tested, e.g. through downstream indicating instruments or the input card of the control system.

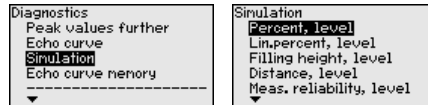

Select the requested simulation variable and set the requested value.

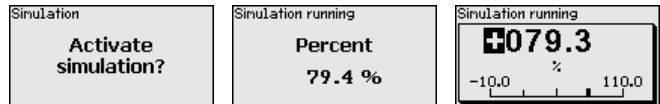

### Caution:

During simulation, the simulated value is output as 4 ... 20 mA current value and digital HART signal.

Push the **[ESC]** key to deactivate the simulation.



### Information:

The simulation is terminated automatically 60 minutes after the activation of the simulation.

## Diagnostics - Echo curve memory

With the menu item "Setup" the echo curve it is possible to save at the time of setup. This is generally recommended; for using the Asset Management functions it is necessary. If possible, the curve should be saved with a low level in the vessel.

This allows you to detect signal changes over the operating time.



The function "Echo curve memory" enables storing echo curves of the measurement.

Under the sub-menu item "Echo curve memory" you can store the current echo curve.

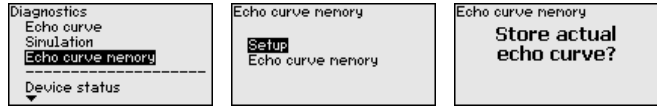

**Additional settings - Reset**

After a reset, certain parameter adjustments made by the user are reset.



**Note:**

After this menu window, the reset process is carried out. No further safety inquiry follows.



The following reset functions are available:

**Delivery status:** Restores the parameter settings at the time of shipment from the factory, incl. order-specific settings. Any stored false signal suppression or user-programmed linearisation curve, as well as the measured value memory, are deleted.

**Basic settings:** Restores the parameter settings, incl. special parameters, to the default values of the respective instrument. Any stored false signal suppression or user-programmed linearisation curve, as well as the measured value memory, are deleted.

The following table shows the default values of the instrument. Depending on the instrument version or application, all menu items may not be available or some may be differently assigned:

**Menu - Setup**

Menu	Menu item	Default value
Setup	Lock adjustment	Released
	Measurement loop name	Sensor
	Units	Distance unit: order-specific Temperature unit: order-specific
	Probe length	Länge der Messsonde factory setting
	Type of medium	Liquid
	Application	Level, vessel
	Medium, dielectric constant	Water-based, > 10
	Superimposed gas phase	Yes
	Dielectric constant, upper medium (TS)	1.5
Tube inner diameter	200 mm	

Menu	Menu item	Default value
Setup	Max. adjustment - Level	100 % Distance: 0.000 m(d) - note blocking distances
	Min. adjustment - Level	0 % Distance: Probe length - take dead band into account
	Max. adjustment - Interface	100 % Distance: 0.000 m(d) - note blocking distances
	Min. adjustment - Interface	0 % Distance: Probe length - take dead band into account
Setup	Damping - Level	0.0 s
	Damping - Interface	0.0 s
Setup	Linearisation type	Linear
	Linearisation - Socket correction	0 mm
	Linearisation - Vessel height	Probe length
Setup	Scaling variable - Level	Volume in l
	Scaling unit - Level	Litres
	Scaling format - Level	Without decimal positions
	Scaling level - 100 % corresponds to	100
	Scaling level - 0 % corresponds to	0
	Scaling variable - Interface	Volume
	Scaling unit - Interface	Litres
	Scaling format - Interface	Without decimal positions
	Scaling interface - 100 % corresponds to	100
Scaling interface - 0 % corresponds to	0	
Setup	Current output, output variable	Lin. percent - Level
	Current output - Output characteristics	0 ... 100 % correspond to 4 ... 20 mA
	Current output - Reaction in case of fault	≤ 3.6 mA
	Current output - Min.	3.8 mA
	Current output - Max.	20.5 mA
	Current output 2 - Output variable	Distance - Level
	Current output 2 - Output characteristics	0 ... 100 % correspond to 4 ... 20 mA
	Current output 2 - Reaction in case of fault	≤ 3.6 mA
	Current output 2 - Min.	3.8 mA
Current output 2 - Max.	20.5 mA	

### Menu - Display

Menu	Menu item	Default value
Display	Language	Selected language
	Displayed value 1	Filling height
	Displayed value 2	Electronics temperature
	Display format 1	Automatically
	Display format 2	Automatically
	Backlight	Switched on

### Menu - Additional adjustments

Menu	Menu item	Default value
Additional adjustments	PIN	0000
	Date	Actual date
	Time	Actual time
	Time - Format	24 hours
	Probe type	Device-specific

### Additional settings - Copy instrument settings

The instrument settings are copied with this function. The following functions are available:

- Read from sensor: Read data from sensor and save in the display and adjustment module
- Write to sensor: Save data from the display and adjustment module back into the sensor

The following data or settings for adjustment of the display and adjustment module are saved:

- All data of the menu "Setup" and "Display"
- In the menu "Additional adjustments" the items "Reset, Date/Time"
- Special parameters

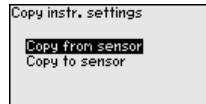
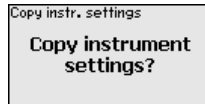

The copied data are permanently saved in an EEPROM memory in the display and adjustment module and remain there even in case of power failure. From there, they can be written into one or more sensors or kept as backup for a possible electronics exchange.



#### Note:

Before the data are stored in the sensor, a check is carried out to determine if the data fit the sensor. If the data do not fit, a fault signal is triggered or the function is blocked. When data are being written into the sensor, the display shows which instrument type the data originate from and which TAG-no. this sensor had.

**Tip:**

We recommend to save the instrument adjustments. In case of an electronics exchange the saved parameter adjustment data relieve this process.

**Additional settings - Scaling level**

Since scaling is very extensive, scaling of the level value was divided into two menu items.

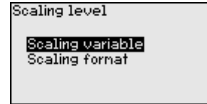
**Additional settings - Scaling level - Scaling variable**

In menu item "Scaling variable" you define the scaling variable and the scaling unit for the level value on the display, e.g. volume in l.

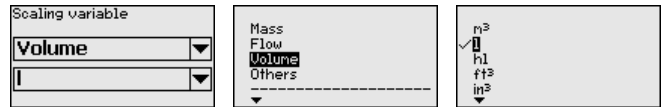
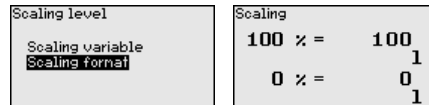
**Additional settings - Scaling level - Scaling format**

In menu item "Scaling format" you define the scaling format on the display and the scaling of the measured level value for 0 % and 100 %.

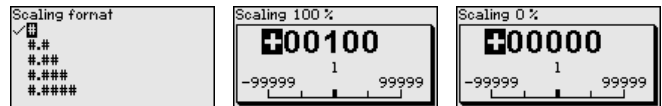
**Additional settings - Scaling interface**

Since scaling is very extensive, scaling of the interface value was divided into two menu items.

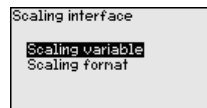

**Additional settings - Scaling interface - Scaling variable**

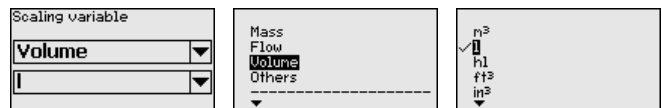
In menu item "Scaling variable" you define the scaling variable and the scaling unit for the interface value on the display, e.g. volume in l.

**Additional settings - Scaling interface - Scaling format**

In menu item "Scaling format" you define the scaling format on the display and the scaling of the measured interface value for 0 % and 100 %.

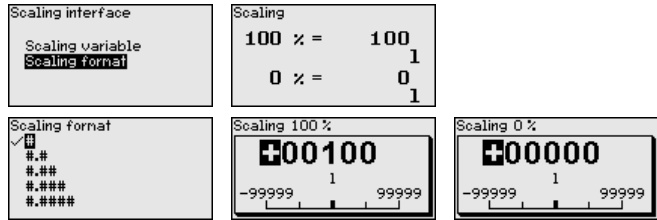
6 Set up with the display and adjustment module



**Additional settings - Current output**

Since scaling is very extensive, scaling of the level value was divided into two menu items.

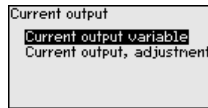

**Additional settings - Current output - Current output, meas. variable**

In menu item "Current output, variable" you specify which measured variable the current output refers to.

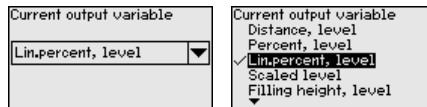

**Additional settings - Current output - Current output, adjustment**

In menu item "Current output, adjustment" you can assign a respective measured value to the current output.

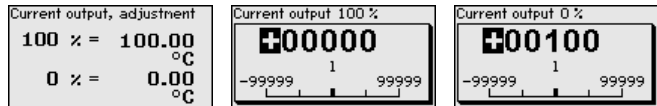

**Additional settings - Probe type**

In this menu item you can select the type and size of your probe from a list of all possible probes. This is necessary to adapt the electronics optimally to the probe.

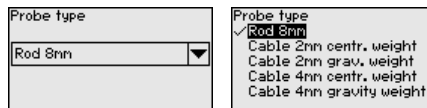

**Additional settings - HART mode**

The sensor offers the HART modes "Analogue current output" and "Fix current (4 mA)". In this menu item you determine the HART mode and enter the address with Multidrop mode.

In the mode "Fixed current output" up to 63 sensors can be operated on one two-wire cable (Multidrop operation). An address between 0 and 63 must be assigned to each sensor.

If you select the function "Analogue current output" and also enter an address number, you can output a 4 ... 20 mA signal in Multidrop mode.

In the mode "Fixed current (4 mA)" a fixed 4 mA signal is output independently of the actual level.



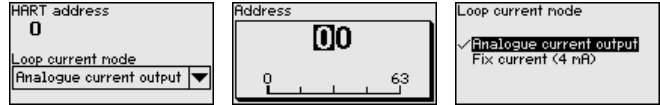

The default setting is "Analogue current output" and the address 00.

### Additional settings - Special parameters

In this menu item you gain access to the protected area where you can enter special parameters. In exceptional cases, individual parameters can be modified in order to adapt the sensor to special requirements.

Change the settings of the special parameters only after having contacted our service staff.



### Info - Instrument name

In this menu, you read out the instrument name and the instrument serial number.

### Info - Instrument version

In this menu item, the hardware and software version of the sensor is displayed.



### Info - Factory calibration date

In this menu item, the date of factory calibration of the sensor as well as the date of the last change of sensor parameters are displayed via the display and adjustment module.



### Info - Sensor characteristics

In this menu item, the features of the sensor such as approval, process fitting, seal, measuring range, electronics, housing and others are displayed.

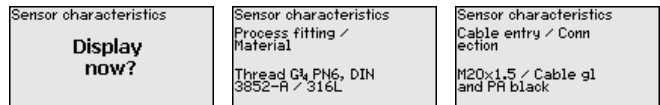

Example for displayed sensor features.

## 6.5 Saving the parameterisation data

We recommended writing down the adjustment data, e.g. in this operating instructions manual, and archiving them afterwards. They are thus available for multiple use or service purposes.

**In the display and adjustment module**

If the instrument is equipped with a display and adjustment module, the parameter adjustment data can be saved therein. The procedure is described in menu item "*Copy device settings*".

## 7 Diagnostics and servicing

### 7.1 Maintenance

#### Maintenance

If the device is used properly, no special maintenance is required in normal operation.

#### Cleaning

The cleaning helps that the type label and markings on the instrument are visible.

Take note of the following:

- Use only cleaning agents which do not corrode the housings, type label and seals
- Use only cleaning methods corresponding to the housing protection rating

### 7.2 Diagnosis memory

The instrument has several memories available for diagnostic purposes. The data remain there even in case of voltage interruption.

### 7.3 Status messages

The instrument features self-monitoring and diagnostics according to NE 107 and VDI/VDE 2650. In addition to the status messages in the following tables there are more detailed error messages available under the menu item "Diagnostics" via the display and adjustment module.

#### Status messages

The status messages are divided into the following categories:

- Failure
- Function check
- Out of specification
- Maintenance requirement

and explained by pictographs:

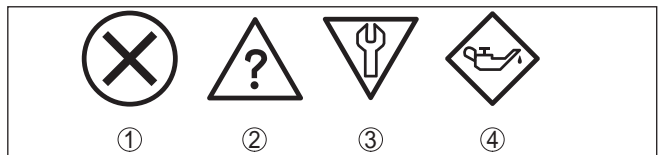

Fig. 15: Pictographs of the status messages

- 1 Failure - red
- 2 Out of specification - yellow
- 3 Function check - orange
- 4 Maintenance - blue

**Failure:** Due to a malfunction in the instrument, a fault message is output.

This status message is always active. It cannot be deactivated by the user.

**Function check:** The instrument is being worked on, the measured value is temporarily invalid (for example during simulation).

This status message is inactive by default.

**Out of specification:** The measured value is unreliable because an instrument specification was exceeded (e.g. electronics temperature).

This status message is inactive by default.

**Maintenance:** Due to external influences, the instrument function is limited. The measurement is affected, but the measured value is still valid. Plan in maintenance for the instrument because a failure is expected in the near future (e.g. due to buildup).

This status message is inactive by default.

**Failure**

Code Text message	Cause	Rectification	DevSpec State in CMD 48
F013 no measured value available	<ul style="list-style-type: none"> <li>● Sensor does not detect an echo during operation</li> <li>● Process component or probe contaminated or defective</li> </ul>	<ul style="list-style-type: none"> <li>● Check for correct mounting and/or parameter settings</li> <li>● Clean or exchange process component or probe</li> </ul>	Bit 0 of Byte 0 ... 5
F017 Adjustment span too small	<ul style="list-style-type: none"> <li>● Adjustment not within specification</li> </ul>	<ul style="list-style-type: none"> <li>● Change adjustment according to the limit values (difference between min. and max. ≥ 10 mm)</li> </ul>	Bit 1 of Byte 0 ... 5
F025 Error in the linearization table	<ul style="list-style-type: none"> <li>● Index markers are not continuously rising, for example illogical value pairs</li> </ul>	<ul style="list-style-type: none"> <li>● Check values of the linearization table</li> <li>● Delete/create a new linearization table</li> </ul>	Bit 2 of Byte 0 ... 5
F036 No operable software	<ul style="list-style-type: none"> <li>● Failed or interrupted software update</li> </ul>	<ul style="list-style-type: none"> <li>● Repeat software update</li> <li>● Check electronics version</li> <li>● Exchanging the electronics</li> <li>● Send instrument for repair</li> </ul>	Bit 3 of Byte 0 ... 5
F040 Error in the electronics	<ul style="list-style-type: none"> <li>● Hardware defect</li> </ul>	<ul style="list-style-type: none"> <li>● Exchanging the electronics</li> <li>● Send instrument for repair</li> </ul>	Bit 4 of Byte 0 ... 5
F041 Probe loss	<ul style="list-style-type: none"> <li>● Probe mechanically defective</li> </ul>	<ul style="list-style-type: none"> <li>● Check probe and exchange, if necessary</li> </ul>	Bit 13 of Byte 0 ... 5
F080 General software error	<ul style="list-style-type: none"> <li>● General software error</li> </ul>	<ul style="list-style-type: none"> <li>● Disconnect operating voltage briefly</li> </ul>	Bit 5 of Byte 0 ... 5
F105 Measured value is determined	<ul style="list-style-type: none"> <li>● The instrument is still in the start phase, the measured value could not yet be determined</li> </ul>	<ul style="list-style-type: none"> <li>● Wait for the end of the switch-on phase</li> <li>● Duration depending on the version and parameter adjustment max. 5 min.</li> </ul>	Bit 6 of Byte 0 ... 5
F113 Communication error	<ul style="list-style-type: none"> <li>● EMC interference</li> <li>● Transmission error during external communication with 4-wire power supply unit</li> </ul>	<ul style="list-style-type: none"> <li>● Remove EMC influences</li> <li>● Exchange 4-wire power supply unit or electronics</li> </ul>	Bit 12 of Byte 0 ... 5

Code Text message	Cause	Rectification	DevSpec State in CMD 48
F260 Error in the calibration	<ul style="list-style-type: none"> <li>● Error in the calibration carried out in the factory</li> <li>● Error in the EEPROM</li> </ul>	<ul style="list-style-type: none"> <li>● Exchanging the electronics</li> <li>● Send instrument for repair</li> </ul>	Bit 8 of Byte 0 ... 5
F261 Error in the instrument settings	<ul style="list-style-type: none"> <li>● Error during setup</li> <li>● Error when carrying out a reset</li> <li>● False signal suppression faulty</li> </ul>	<ul style="list-style-type: none"> <li>● Carry out a reset</li> <li>● Repeat setup</li> </ul>	Bit 9 of Byte 0 ... 5
F264 Installation/ Setup error	<ul style="list-style-type: none"> <li>● Error during setup</li> </ul>	<ul style="list-style-type: none"> <li>● Check for correct mounting and/or parameter settings</li> <li>● Check probe length</li> </ul>	Bit 10 of Byte 0 ... 5
F265 Measurement function disturbed	<ul style="list-style-type: none"> <li>● Sensor no longer carries out a measurement</li> </ul>	<ul style="list-style-type: none"> <li>● Carry out a reset</li> <li>● Disconnect operating voltage briefly</li> </ul>	Bit 11 of Byte 0 ... 5
F267 No executable sensor software	<ul style="list-style-type: none"> <li>● Sensor cannot start</li> </ul>	<ul style="list-style-type: none"> <li>● Exchanging the electronics</li> <li>● Send instrument for repair</li> </ul>	No communication possible

Tab. 5: Error codes and text messages, information on causes as well as corrective measures (some specifications are only valid for four-wire instruments)

### Function check

Code Text message	Cause	Rectification	DevSpec State in CMD 48
C700 Simulation active	<ul style="list-style-type: none"> <li>● A simulation is active</li> </ul>	<ul style="list-style-type: none"> <li>● Finish simulation</li> <li>● Wait for the automatic end after 60 mins.</li> </ul>	"Simulation Active" in "Standardized Status 0"

Tab. 6: Error codes and text messages, information on causes as well as corrective measures

### Out of specification

Code Text message	Cause	Rectification	DevSpec State in CMD 48
S600 Impermissible electronics temperature	<ul style="list-style-type: none"> <li>● Temperature of the processing electronics in the non-specified section</li> </ul>	<ul style="list-style-type: none"> <li>● Check ambient temperature</li> <li>● Insulate electronics</li> <li>● Use instrument with higher temperature range</li> </ul>	Bit 8 of Byte 14 ... 24
S601 Overfilling	<ul style="list-style-type: none"> <li>● Level echo in the close range not available</li> </ul>	<ul style="list-style-type: none"> <li>● Reduce level</li> <li>● 100 % adjustment: Increase value</li> <li>● Check mounting socket</li> <li>● Remove possible interfering signals in the close range</li> <li>● Use coaxial probe</li> </ul>	Bit 9 of Byte 14 ... 24

Code Text message	Cause	Rectification	DevSpec State in CMD 48
S602 Level within the search range, compensation echo	● Compensation echo superimposed by medium	● 100 % adjustment: Increase value	Bit 10 of Byte 14 ... 24
S603 Impermissible operating voltage	● Operating voltage below specified range	● Check electrical connection ● If necessary, increase operating voltage	Bit 11 of Byte 14 ... 24

Tab. 7: Error codes and text messages, information on causes as well as corrective measures

### Maintenance

Code Text message	Cause	Rectification	DevSpec State in CMD 48
M500 Error in the delivery status	● The data could not be restored during the reset to delivery status	● Repeat reset ● Load XML file with sensor data into the sensor	Bit 0 of Byte 14 ... 24
M501 Error in the non-active linearisation table	● Index markers are not continuously rising, for example illogical value pairs	● Check linearisation table ● Delete table/Create new	Bit 1 of Byte 14 ... 24
M504 Error at a device interface	● Hardware defect	● Exchanging the electronics ● Send instrument for repair	Bit 4 of Byte 14 ... 24
M505 no measured value available	● Sensor does not detect an echo during operation	● Check and correct mounting and/or parameter adjustment	Bit 5 of Byte 14 ... 24
	● Process component or probe contaminated or defective	● Clean or exchange process component or probe	
M506 Installation/Set-up error	● Error during setup	● Check and correct mounting and/or parameter adjustment ● Check probe length	Bit 6 of Byte 14 ... 24
M507 Error in the instrument settings	● Error during setup ● Error when carrying out a reset ● False signal suppression faulty	● Carry out reset and repeat setup	Bit 7 of Byte 14 ... 24

Tab. 8: Error codes and text messages, information on causes as well as corrective measures

## 7.4 Rectify faults

### Reaction when malfunction occurs

The operator of the system is responsible for taking suitable measures to rectify faults.

### Procedure for fault rectification

The first measures are:

- Evaluation of fault messages via the adjustment device
- Checking the output signal
- Treatment of measurement errors

## Check the 4 ... 20 mA signal

Connect a multimeter in the suitable measuring range according to the wiring plan. The following table describes possible errors in the current signal and helps to eliminate them:

Error	Cause	Rectification
4 ... 20 mA signal not stable	● Fluctuating measured value	● Set damping
4 ... 20 mA signal missing	● Electrical connection faulty	● Check connection, correct, if necessary
	● Voltage supply missing	● Check cables for breaks; repair if necessary
	● Operating voltage too low, load resistance too high	● Check, adapt if necessary
Current signal greater than 22 mA, less than 3.6 mA	● Sensor electronics defective	● Exchange the instrument or send it in for repair

## Treatment of measurement errors

The below tables show typical examples for application-relevant measurement errors. There are two measurement errors:

- Constant level
- Filling
- Emptying

The images in column "Error pattern" show the real level as a broken line and the level displayed by the sensor as a continuous line.

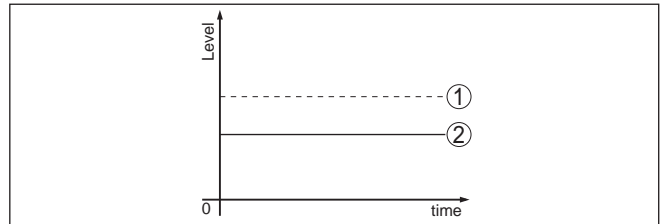

Fig. 16: The broken line 1 shows the real level, the continuous line 2 shows the level displayed by the sensor



### Note:

- Wherever the sensor displays a constant value, the reason could also be the fault setting of the current output to "Hold value"
- If the level indication is too low, the reason could be a line resistance that is too high

## Measurement error with constant level

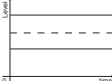
Fault description	Cause	Rectification
1. Measured value shows a too low or too high level 	● Min./max. adjustment not correct	● Adapt min./max. adjustment
	● Incorrect linearisation curve	● Adapt linearisation curve
	● Running time error (small measurement error close to 100 %/serious error close to 0 %)	● Repeat setup

7 Diagnostics and servicing

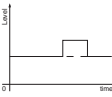

Fault description	Cause	Rectification
2. Measured value jumps towards 100 % 	<ul style="list-style-type: none"> <li>● Due to the process, the amplitude of the product echo decreases</li> <li>● A false signal suppression was not carried out</li> </ul>	<ul style="list-style-type: none"> <li>● Carry out a false signal suppression</li> </ul>
	<ul style="list-style-type: none"> <li>● Amplitude or position of a false signal has changed (e.g. buildup); false signal suppression no longer matches</li> </ul>	<ul style="list-style-type: none"> <li>● Determine the reason for the changed false signals, carry out false signal suppression, e.g. with buildup</li> </ul>

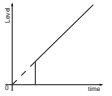
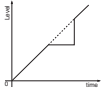
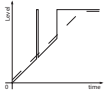
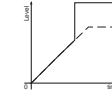
Measurement error during filling

Fault description	Cause	Rectification
3. Measured value remains in the area of the bottom during filling 	<ul style="list-style-type: none"> <li>● Echo from the probe end larger than the product echo, for example, with products with <math>\epsilon_r &lt; 2.5</math> oil-based, solvents, etc.</li> </ul>	<ul style="list-style-type: none"> <li>● Check parameter "Medium" and "Vessel height", adapt if necessary</li> </ul>
4. Measured value remains momentarily unchanged during filling and then jumps to the correct level 	<ul style="list-style-type: none"> <li>● Turbulence on the product surface, quick filling</li> </ul>	<ul style="list-style-type: none"> <li>● Check parameters, change if necessary, e.g. in dosing vessel, reactor</li> </ul>
5. Measured value jumps sporadically to 100 % during filling 	<ul style="list-style-type: none"> <li>● Changing condensation or contamination on the probe</li> </ul>	<ul style="list-style-type: none"> <li>● Carry out a false signal suppression</li> </ul>
6. Measured value jumps to $\geq 100\%$ or 0 m distance 	<ul style="list-style-type: none"> <li>● Level echo is no longer detected in the close range due to false signals in the close range. The sensor goes into overflow protection mode. The max. level (0 m distance) as well as the status message "Overflow protection" are output.</li> </ul>	<ul style="list-style-type: none"> <li>● Eliminate false signals in the close range</li> <li>● Check installation conditions</li> <li>● If possible, switch off the function "Overflow protection"</li> </ul>



## Measurement error during emptying

Fault description	Cause	Rectification
7. Measured value remains unchanged in the close range during emptying 	<ul style="list-style-type: none"> <li>● False signal larger than the level echo</li> <li>● Level echo too small</li> </ul>	<ul style="list-style-type: none"> <li>● Eliminate false signals in the close range</li> <li>● Remove contamination on the probe. After having removed the source of the false signals, the false signal suppression must be deleted.</li> <li>● Carry out a new false signal suppression</li> </ul>
8. Measured value remains reproducible in one position during emptying 	<ul style="list-style-type: none"> <li>● Stored false signals in this position are larger than the level echo</li> </ul>	<ul style="list-style-type: none"> <li>● Delete false signal suppression</li> <li>● Carry out a new false signal suppression</li> </ul>

### Reaction after fault rectification

Depending on the reason for the fault and the measures taken, the steps described in chapter "Setup" must be carried out again or must be checked for plausibility and completeness.

## 7.5 Exchanging the electronics module

If the electronics module is defective, it can be replaced by the user.



In Ex applications, only instruments and electronics modules with appropriate Ex approval may be used.

If there is no electronics module available on site, the electronics module can be ordered through the agency serving you. The electronics modules are adapted to the respective sensor and differ in signal output or voltage supply.

The new electronics module must be loaded with the default settings of the sensor. These are the options:

- In the factory
- Or on site by the user

In both cases, the serial number of the sensor is needed. The serial numbers are stated on the type label of the instrument, on the inside of the housing as well as on the delivery note.

When loading on site, the order data must first be downloaded from the Internet (see operating instructions "Electronics module").



### Caution:

All application-specific settings must be entered again. That's why you have to carry out a fresh setup after exchanging the electronics.

If you saved the parameter settings during the first setup of the sensor, you can transfer them to the replacement electronics module. A fresh setup is then not necessary.

## **7.6 How to proceed if a repair is necessary**

If it is necessary to repair the instrument, please contact the agency serving you.

## 8 Dismount

### 8.1 Dismounting steps

**Warning:**

Before dismantling, be aware of dangerous process conditions such as e.g. pressure in the vessel or pipeline, high temperatures, corrosive or toxic products etc.

Take note of chapters "*Mounting*" and "*Connecting to voltage supply*" and carry out the listed steps in reverse order.

### 8.2 Disposal

The instrument consists of materials which can be recycled by specialised recycling companies. We use recyclable materials and have designed the electronics to be easily separable.

**WEEE directive**

The instrument does not fall in the scope of the EU WEEE directive. Article 2 of this Directive exempts electrical and electronic equipment from this requirement if it is part of another instrument that does not fall in the scope of the Directive. These include stationary industrial plants.

Pass the instrument directly on to a specialised recycling company and do not use the municipal collecting points.

If you have no way to dispose of the old instrument properly, please contact us concerning return and disposal.

## 9 Supplement

### 9.1 Technical data

#### General data

316L corresponds to 1.4404 or 1.4435

#### Materials, wetted parts

- Process fitting 316L and PEEK
- Process seal on the instrument side (rod leadthrough) FKM (SHS FPM 70C3 GLT), FFKM (Kalrez 6375), EPDM (A+P 70.10-02), silicone FEP coated (A+P FEP-O-SEAL)
- Process fitting (for volatile substances such as e.g. Ammonia) 316L
- Process seal, process side (for volatile substances such as e.g. Ammonia) Borosilicate glass GPC 540 with 316L and Alloy C22 (2.4602)<sup>1)</sup>
- Process seal On site (instruments with thread: Klingersil C-4400 is enclosed)
- Inner conductor (up to the separation rod) 316L
- Spacers PFA
- Tube:  $\varnothing$  21.3 mm (0.839 in) 316L, 304L
- Tube:  $\varnothing$  42.2 mm (1.661 in) 316L, 304L

#### Materials, non-wetted parts

- Aluminium die-cast housing Aluminium die-casting AlSi10Mg, powder-coated (Basis: Polyester)
- Stainless steel housing (electropolished) 316L
- Temperature adapter 316L
- Second Line of Defense (optional) Borosilicate glass GPC 540 with 316L
- Seal between housing and housing lid Silicone SI 850 R
- Inspection window in housing cover (optional) Glass
- Ground terminal 316L
- Cable gland PA, stainless steel, brass
- Sealing, cable gland NBR
- Blind plug, cable gland PA

#### Second Line of Defense (optional)

The Second Line of Defense (SLOD) is a second level of the process separation in the form of a gas-tight feedthrough in the lower part of the housing, preventing product from penetrating into the housing.

- Supporting material 316L
- Glass potting Borosilicate glass GPC 540

<sup>1)</sup> Not suitable for hot steam applications.

- Contacts	Alloy C22 (2.4602)
- Helium leak rate	< 10 <sup>-6</sup> mbar l/s
- Pressure resistance	See process pressure of the sensor
Conductive connection	Between ground terminal, process fitting and probe
Process fittings - tube: ø 21.3 mm (0.839 in)	
- Pipe thread, cylindrical (ISO 228 T1)	G <sup>3</sup> / <sub>4</sub> , G1, G1 <sup>1</sup> / <sub>2</sub> (DIN 3852-A)
- Pipe thread, conical (ASME B1.20.1)	<sup>3</sup> / <sub>4</sub> NPT, 1 NPT, 1 <sup>1</sup> / <sub>2</sub> NPT
- Flanges	DIN from DN 25, ASME from 1"
Process fittings - tube: ø 42.2 mm (1.661 in)	
- Pipe thread, cylindrical (ISO 228 T1)	G1 <sup>1</sup> / <sub>2</sub> (DIN 3852-A)
- Pipe thread, conical (ASME B1.20.1)	1 <sup>1</sup> / <sub>2</sub> NPT
- Flanges	DIN from DN 50, ASME from 2"
Weight	
- Instrument weight (depending on process fitting)	approx. 0.8 ... 8 kg (0.176 ... 17.64 lbs)
- Tube: ø 21.3 mm (0.839 in)	approx. 1110 g/m (11.9 oz/ft)
- Tube: ø 42.2 mm (1.661 in)	approx. 3100 g/m (33.3 oz/ft)
Probe length L (from seal surface)	
- Tube: ø 21.3 mm (0.839 in)	up to 6 m (19.69 ft)
- Tube: ø 42.2 mm (1.661 in)	up to 6 m (19.69 ft)
- Trimming accuracy (tube)	±1 mm
Lateral load	
- Tube: ø 21.3 mm (0.839 in)	60 Nm (44 lbf ft)
- Tube: ø 42.2 mm (1.661 in)	300 Nm (221 lbf ft)
Torque for NPT cable glands and Conduit tubes	
- Aluminium/Stainless steel housing	max. 50 Nm (36.88 lbf ft)

---

### Input variable

---

Measured variable	Level of liquids
Min. dielectric constant of the medium	$\epsilon_r \geq 1.4$

---

### Output variable

---

Output signal	4 ... 20 mA/HART
Range of the output signal	3.8 ... 20.5 mA/HART (default setting)
Fulfilled HART specification	7
Signal resolution	0.3 µA
Fault signal, current output (adjustable)	Last valid measured value, $\geq 21$ mA, $\leq 3.6$ mA
Max. output current	21.5 mA
Starting current	$\leq 10$ mA for 5 ms after switching on, $\leq 3.6$ mA
Load	see load under Power supply
Damping (63 % of the input variable), adjustable	0 ... 999 s

HART output values according to HART 7 (default setting)<sup>2)</sup>

- First HART value (PV)                      Linearised percentage value, level
- Second HART value (SV)                    Distance to the level
- Third HART value (TV)                      Measurement reliability, level
- Fourth HART value (QV)                    Electronics temperature

Indication value - Display and adjustment module<sup>3)</sup>

- Displayed value 1                            Filling height Level
- Displayed value 2                            Electronics temperature

Resolution, digital                              < 1 mm (0.039 in)

**Measurement accuracy (according to DIN EN 60770-1)**

Process reference conditions according to DIN EN 61298-1

- Temperature                                    +18 ... +30 °C (+64 ... +86 °F)
- Relative humidity                            45 ... 75 %
- Air pressure                                    +860 ... +1060 mbar/+86 ... +106 kPa  
(+12.5 ... +15.4 psig)

Mounting, reference conditions

- Min. distance to internal installations    > 500 mm (19.69 in)
- Vessel    metallic, ø 1 m (3.281 ft), centric mounting, process fitting flush with the vessel ceiling
- Medium    Water/Oil (dielectric constant ~2.0)<sup>4)</sup>
- Mounting                                        Probe end does not touch the vessel bottom

Sensor parameter adjustment              No gating out of false signals carried out

<sup>2)</sup> The output values can be assigned individually.  
<sup>3)</sup> The indication values can be assigned individually.  
<sup>4)</sup> With interface measurement = 2.0.

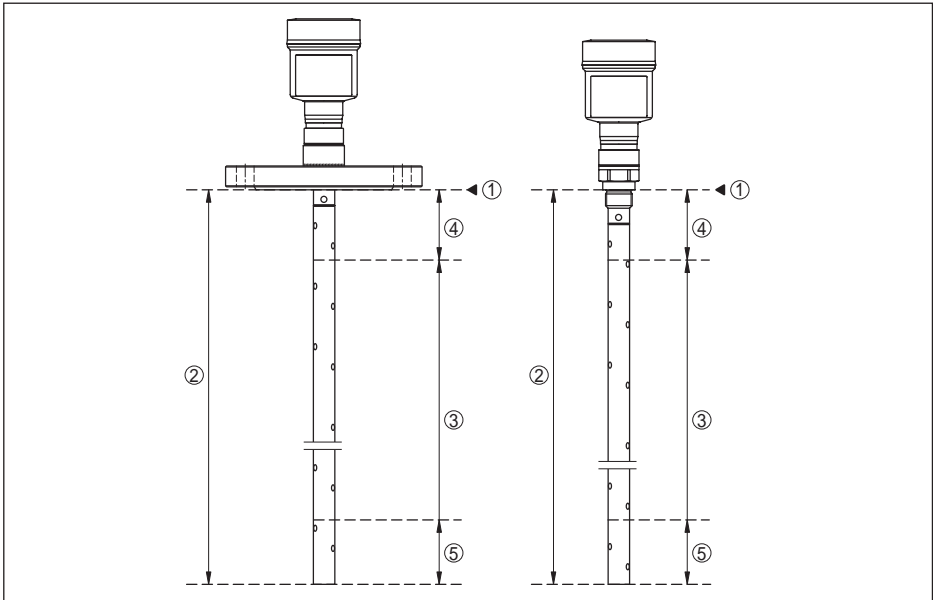

Fig. 25: Measuring ranges - NivoGuide 8100

- 1 Reference plane
- 2 Probe length  $L$
- 3 Measuring range (default setting refers to the measuring range in water)
- 4 Upper dead band (see following diagrams - grey section)
- 5 Lower dead band (see following diagrams - grey section)

Typical deviation - Interface measurement  $\pm 5 \text{ mm (0.197 in)}$

Typical deviation - Total level interface measurement  $\pm 5 \text{ mm (0.197 in)}$

Typical deviation - Level measurement<sup>5)6)</sup> See following diagrams

<sup>5)</sup> Depending on the mounting conditions, deviations can occur which can be rectified by adapting the adjustment or changing the measured value offset in the DTM service mode.

<sup>6)</sup> The dead bands can be optimized via a false signal suppression.

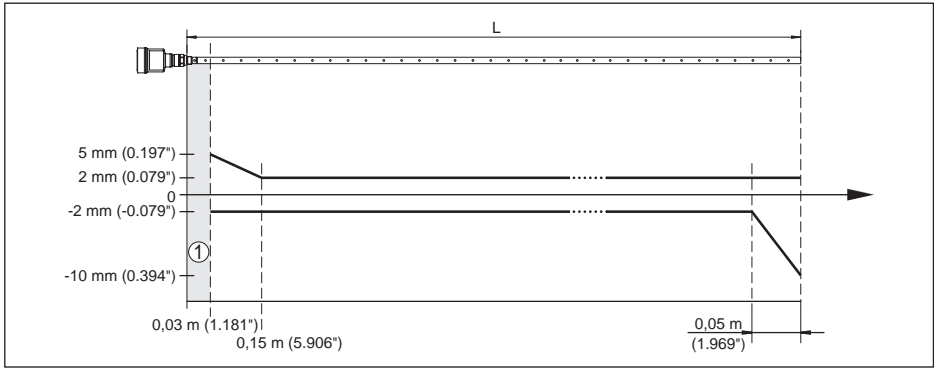

Fig. 26: Deviation NivoGuide 8100 in coaxial version in water

- 1 Dead band (no measurement possible in this area)
- L Probe length

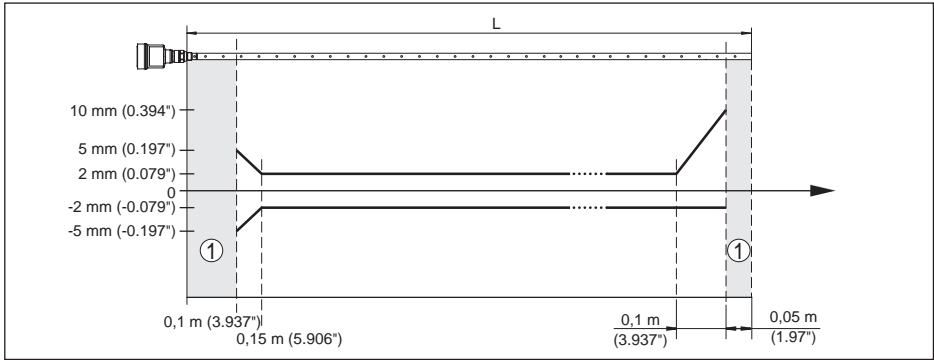

Fig. 27: Deviation NivoGuide 8100 in coaxial version in oil

- 1 Dead band (no measurement possible in this area)
- L Probe length

Repeatability  $\leq \pm 1$  mm

### Variables influencing measurement accuracy

#### Specifications for the digital measured value

Temperature drift - Digital output  $\pm 3$  mm/10 K relating to the max. measuring range or max. 10 mm (0.394 in)

Additional deviation through electromagnetic interference acc. to EN 61326  $< \pm 10$  mm ( $< \pm 0.394$  in)

#### Specifications apply also to the current output<sup>7)</sup>

Temperature drift - Current output  $\pm 0.03$  %/10 K relating to the 16 mA span or max.  $\pm 0.3$  %

Deviation in the current output due to digital/analogue conversion

- Non-Ex and Ex-ia version  $< \pm 15$   $\mu$ A
- Ex-d-ia version  $< \pm 40$   $\mu$ A

<sup>7)</sup> Also for the additional current output (optional).



Additional deviation through electromag- <math>\lt; \pm 150 \mu\text{A}</math>  
netic interference acc. to EN 61326

### Influence of the superimposed gas and pressure on measurement accuracy

The propagation speed of the radar impulses in gas or vapour above the medium is reduced by high pressure. This effect depends on the superimposed gas or vapours.

The following table shows the resulting deviation for some typical gases and vapours. The specified values refer to the distance. Positive values mean that the measured distance is too large, negative values that the measured distance is too small.

Gas phase	Temperature	Pressure		
		1 bar (14.5 psig)	10 bar (145 psig)	50 bar (725 psig)
Air	20 °C (68 °F)	0 %	0.22 %	1.2 %
	200 °C (392 °F)	-0.01 %	0.13 %	0.74 %
	400 °C (752 °F)	-0.02 %	0.08 %	0.52 %
Hydrogen	20 °C (68 °F)	-0.01 %	0.1 %	0.61 %
	200 °C (392 °F)	-0.02 %	0.05 %	0.37 %
	400 °C (752 °F)	-0.02 %	0.03 %	0.25 %
Steam (saturated steam)	100 °C (212 °F)	0.26 %	-	-
	180 °C (356 °F)	0.17 %	2.1 %	-
	264 °C (507 °F)	0.12 %	1.44 %	9.2 %
	366 °C (691 °F)	0.07 %	1.01 %	5.7 %

### Characteristics and performance data

Measuring cycle time	< 500 ms
Step response time <sup>8)</sup>	≤ 3 s
Max. filling/emptying speed	1 m/min
	Products with high dielectric constant (>10) up to 5 m/min.

### Ambient conditions

Ambient, storage and transport tempera- -40 ... +80 °C (-40 ... +176 °F)  
ture

### Process conditions

For the process conditions, please also note the specifications on the type label. The lowest value always applies.

The measurement error through the process conditions in the specified pressure and temperature range is < 1 %.

Process pressure

– Standard version -1 ... +40 bar/-100 ... +4000 kPa (-14.5 ... +580 psig),  
depending on the process fitting

<sup>8)</sup> Time span after a sudden measuring distance change by max. 0.5 m in liquid applications, max 2 m with bulk solids applications, until the output signal has taken for the first time 90 % of the final value (IEC 61298-2).

- with borosilicate glass leadthrough -1 ... +100 bar/-100 ... +10000 kPa (-14.5 ... +1450 psig), depending on the process fitting
- Vessel pressure relating to the flange nominal pressure stage see supplementary instructions manual "*Flanges according to DIN-EN-ASME-JIS*"
- Process temperature (thread or flange temperature)
- FKM (SHS FPM 70C3 GLT) -40 ... +150 °C (-40 ... +302 °F)
  - EPDM (A+P 70.10-02) -40 ... +150 °C (-40 ... +302 °F)
  - FFKM (Kalrez 6375) -20 ... +150 °C (-4 ... +302 °F)
  - FFKM (Kalrez 6375) -20 ... +200 °C (-4 ... +392 °F)
  - with borosilicate glass leadthrough -60 ... +150 °C (-76 ... +302 °F)

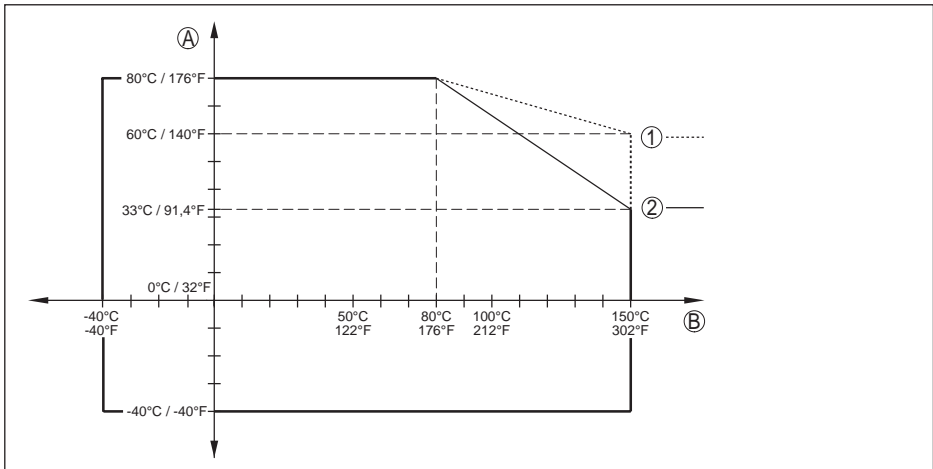

Fig. 28: Ambient temperature - process temperature, standard version

- A Ambient temperature
- B Process temperature (depending on the seal material)
- 1 Aluminium housing
- 2 Plastic housing
- 3 Stainless steel housing (precision casting)
- 4 Stainless steel housing (electropolished)

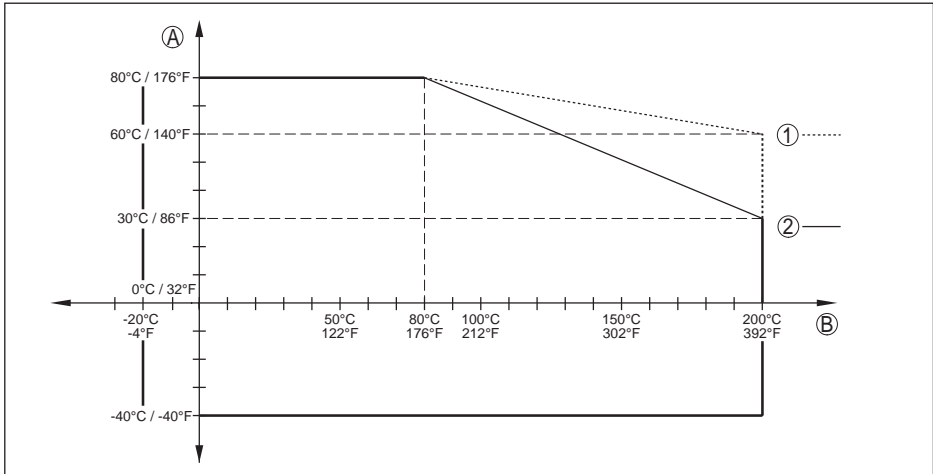

Fig. 29: Ambient temperature - process temperature, version with temperature adapter

- A Ambient temperature  
 B Process temperature (depending on the seal material)  
 1 Aluminium housing  
 2 Plastic housing  
 3 Stainless steel housing (precision casting)  
 4 Stainless steel housing (electropolished)

Viscosity - dynamic	0.1 ... 500 mPa s (requirement: with density 1)
Vibration resistance	
– Coax probe	1 g with 5 ... 200 Hz according EN 60068-2-6 (vibration at resonance) with tube length 50 cm (19.69 in)
Shock resistance	
– Coax probe	25 g, 6 ms according to EN 60068-2-27 (mechanical shock) with tube length 50 cm (19.69 in)

### Electromechanical data - version IP 66/IP 67 and IP 66/IP 68; 0.2 bar

Cable entry	
– M20 x 1.5	1 x cable gland M20 x 1.5 (cable: $\varnothing$ 6 ... 12 mm), 1 x blind plug M20 x 1.5
– ½ NPT	1 x blind plug NPT, 1 x closing cap (red) ½ NPT
Wire cross-section (spring-loaded terminals)	
– Massive wire, stranded wire	0.2 ... 2.5 mm <sup>2</sup> (AWG 24 ... 14)
– Stranded wire with end sleeve	0.2 ... 1.5 mm <sup>2</sup> (AWG 24 ... 16)

### Electromechanical data - version IP 66/IP 68 (1 bar)

Connection cable	
– Configuration	four wires, one suspension cable, braiding, metal foil, cover
– Wire cross-section	0.5 mm <sup>2</sup> (AWG 20)

## 9 Supplement

- Wire resistance	< 0.036 $\Omega$ /m
- Tensile strength	< 1200 N (270 lbf)
- Standard length	5 m (16.4 ft)
- Max. length	180 m (590.6 ft)
- Min. bending radius	25 mm (0.984 in) with 25 °C (77 °F)
- Diameter approx.	8 mm (0.315 in)
- Colour - Non-Ex version	Black
- Colour - Ex-version	Blue

---

**Display and adjustment module**

---

Display element	Display with backlight
Measured value indication	
- Number of digits	5
Adjustment elements	
- 4 keys	<b>[OK], [-&gt;], [+], [ESC]</b>
- Switch	Bluetooth On/Off
Bluetooth interface	
- Standard	Bluetooth smart
- Effective range	25 m (82.02 ft)
Protection rating	
- unassembled	IP 20
- Mounted in the housing without lid	IP 40
Materials	
- Housing	ABS
- Inspection window	Polyester foil
Functional safety	SIL non-reactive

---

**Integrated clock**

---

Date format	Day.Month.Year
Time format	12 h/24 h
Time zone, factory setting	CET
Max. rate deviation	10.5 min/year

---

**Additional output parameter - Electronics temperature**

---

Range	-40 ... +85 °C (-40 ... +185 °F)
Resolution	< 0.1 K
Deviation	$\pm$ 3 K
Output of the temperature values	
- Indication	Via the display and adjustment module
- Analogue	Via the current output

## Voltage supply

Operating voltage  $U_B$

- Non-Ex instrument 9.6 ... 35 V DC
- Ex-ia instrument 9.6 ... 30 V DC

Operating voltage  $U_B$  with lighting switched on

- Non-Ex instrument 16 ... 35 V DC
- Ex-ia instrument 16 ... 30 V DC

Reverse voltage protection Integrated

Permissible residual ripple - Non-Ex, Ex-ia instrument

- for  $9.6 \text{ V} < U_B < 14 \text{ V}$   $\leq 0.7 V_{\text{eff}}$  (16 ... 400 Hz)
- for  $18 \text{ V} < U_B < 36 \text{ V}$   $\leq 1.0 V_{\text{eff}}$  (16 ... 400 Hz)

Load resistor

- Calculation  $(U_B - U_{\text{min}})/0.022 \text{ A}$
- Example - Non-Ex instrument with  $U_B = 24 \text{ V DC}$   
 $(24 \text{ V} - 9.6 \text{ V})/0.022 \text{ A} = 655 \Omega$

## Potential connections and electrical separating measures in the instrument

Electronics	Not non-floating
Reference voltage <sup>9)</sup>	500 V AC
Conductive connection	Between ground terminal and metallic process fitting

## Electrical protective measures

Housing material	Version	Protection acc. to IEC 60529	Protection acc. to NEMA
Aluminium	Single chamber	IP 66/IP 68 (0.2 bar)	Type 6P
	Double chamber	IP 66/IP 68 (0.2 bar)	Type 6P
Stainless steel (electro-polished)	Single chamber	IP 66/IP 68 (0.2 bar)	Type 6P

Connection of the feeding power supply unit Networks of overvoltage category III

Altitude above sea level

- by default up to 2000 m (6562 ft)
- with connected overvoltage protection up to 5000 m (16404 ft)

Pollution degree (with fulfilled housing protection) 4

Protection rating (IEC 61010-1) III

## Approvals

Instruments with approvals can have deviating technical data (depending on the version). For such instruments, the corresponding approval documents must be noted.

<sup>9)</sup> Galvanic separation between electronics and metal housing parts

## 9.2 Dimensions

The following dimensional drawings are only an extract of the possible versions.

### Aluminium housing

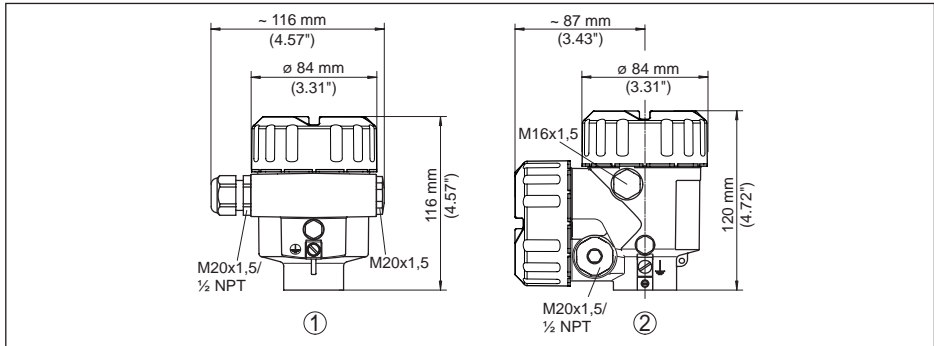

Fig. 30: Housing versions with protection rating IP 66/IP 68 (0.2 bar), (with integrated display and adjustment module the housing is 9 mm/0.35 in higher)

- 1 Aluminium - single chamber
- 2 Aluminium - double chamber

### Stainless steel housing

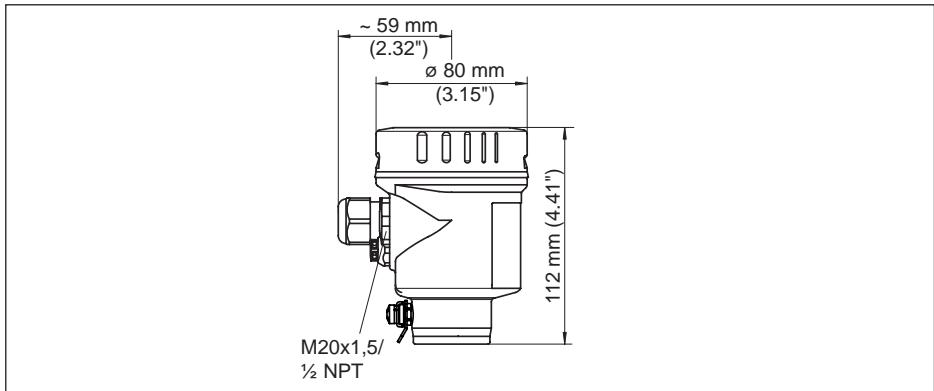

Fig. 31: Housing versions with protection rating IP 66/IP 68 (0.2 bar), (with integrated display and adjustment module the housing is 9 mm/0.35 in higher)

- 1 Stainless steel single chamber (electropolished)
- 2 Stainless steel single chamber (precision casting)
- 3 Stainless steel double chamber housing (precision casting)



### **9.3 Trademark**

All the brands as well as trade and company names used are property of their lawful proprietor/originator.



## INDEX

### A

- Adjustment
  - Max. adjustment 27, 28
  - Min. adjustment 27, 28
- Adjustment system 23
- Application 26, 27
- Application area 8

### B

- Backlight 33

### C

- Check output signal 47
- Copy sensor settings 38
- Current output 40
- Current output, adjustment 40
- Current output, meas. variable 40
- Current output, min./max. 30
- Current output mode 30
- Curve display
  - Echo curve 35

### D

- Damping 28
- Date of manufacture 41
- Default values 36
- Deviation 47
- Display format 33

### E

- Echo curve of the setup 35
- Electrical connection 16, 17
- Electronics and connection compartment 19
- Electronics compartment - double chamber housing 19
- Error codes 45

### F

- Factory calibration date 41
- False signal suppression 30
- Fault rectification 46
- Functional principle 8

### G

- Gas phase 26
- Grounding 17

### H

- HART address 40

### I

- Inflowing medium 13
- Installation position 13

### K

- Key function 22

### L

- Language 32
- Linearisation 29
- Lock adjustment 31

### M

- Main menu 24
- Measured value indication 32
- Measurement loop name 25
- Measurement reliability 34

### N

- NAMUR NE 107
  - Failure 44
  - Maintenance 46
  - Out of specification 45

### P

- Peak value indicator 33, 34
- Probe length 25
- Probe type 40

### Q

- Quick setup 24

### R

- Read out info 41
- Repair 50
- Replacement parts
  - Electronics module 11
- Reset 36

### S

- Scaling measured value 39
- Sensor characteristics 41
- Sensor status 33
- Simulation 35
- Special parameters 41
- Status messages - NAMUR NE 107 43

### T

- Type label 7
- Type of medium 26

## U

Units 25

Printing date:

All statements concerning scope of delivery, application, practical use and operating conditions of the sensors and processing systems correspond to the information available at the time of printing.

Subject to change without prior notice

### **Technical support**

Please contact your local sales partner (address at [www.uwt.de](http://www.uwt.de)). Otherwise please contact us:

UWT GmbH  
Westendstraße 5  
87488 Betzigau  
Germany

Phone +49 831 57123-0  
Fax +49 831 76879  
[info@uwt.de](mailto:info@uwt.de)  
[www.uwt.de](http://www.uwt.de)