



# I. O. & M. Manual

**Installation**

**Operation**

**Maintenance**

**.187 and .250 Orifice  
Valves and Manifolds with  
Pressure-Core™ or O-Ring  
Stem Seal**

Form IOM-VMPC, Revision 01  
Apr. 2003

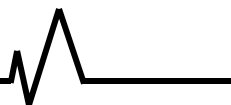

**PGI International**

*Excellence Through Innovation*

16101 Vallen Drive Houston, Texas 77041  
(713) 466-0056 (800) 231-0233 Fax: (800) 568-9228

# I. I. O. & M. INSTRUCTIONS

## *For .187 and .250 Orifice Valves and Manifolds with Pressure-Core™ or O-Ring Stem Seal*

### 1.0 INTRODUCTION

This valve/manifold is supplied with either a soft seat or a hard seat sealing option. Also, an optional Pressure-Core™ or O-Ring seal is available. These stem seals require no adjustment and are positioned below the threads for long service life.

### 2.0 INSTALLATION

2.1 Remove the valve/manifold from the shipping box and check the body stamping for correct part or identification number.

2.2 Prior to valve/manifold installation, check the piping to which the valve or manifold is to be connected for cleanliness and remove any foreign debris.

#### 2.3 Thread Valve Installation

2.3.1 All pipe or fitting connections must be made tight. NPT pipe joints depend on a good, smooth engagement between the male and female pipe threads, usually with the use of a thread sealant. Typically, Grafoil tape is used in high temperature applications. For low temperature applications, Teflon tape or other standard pipe thread sealants may be used.

2.3.2 Check the threads on both the valve/manifold and the mating pipe for cleanliness.

2.3.3 Do not use excessive wrenching force on an NPT pipe joint. Refer to the chart below for the proper torque for your NPT pipe connection fitting.

PIPE OR TUBE ANSI/ASME B1.20.1 NOMINAL INCH	TIGHTENING TORQUE		
	INCH-POUNDS IN-LBS	FOOT-POUNDS FT-LBS	METER-NEWTONS M-N
1/4	600	50	68
3/8	700	58	79
1/2	850	71	96
3/4	1,000	83	113
1	1,200	100	136

### 3.0 OPERATION

3.1 Hand valves which have been reasonably matched to a typical service application and properly installed in its piping system can be expected to have a long service life with minimum attention. However, valves have moving and wearing parts and depend on long term preservation of highly finished surfaces on certain working parts for satisfactory performance.

3.2 The handle of the valve has been designed to provide an adequate seating force to seal the valve against the maximum pressure of the valve without the use of additional mechanical advantage. The use of a “cheater” to operate the valve is **not necessary, not recommended, and can cause valve damage.**

3.3 All valves have rising stems with right-hand thread. Rotate the handle counter-clockwise to open and clockwise to close.

# I. I. O. & M. INSTRUCTIONS

---

## 3.0 OPERATION (cont'd)

- 3.4 Valves with rising stems are provided with a backseat. The backseat is a shoulder on the stem or other part of the stem-disk assembly which engages a corresponding seat shoulder on the inside of the bonnet.

It has become generally recognized that the use of the stem backseat for stem sealing may mask unsatisfactory condition of the stem seal. For this reason, the use of the backseat for normal operation stem sealing is NOT recommended. The backseat in rising stem valves should be regarded simply as a “stop” to prevent overtravel when opening the valves. Normal practice should be to unseat the backseat slightly.

If it is necessary to use the backseat for stem sealing, it should be recognized that backseats are usually smaller than the main seat and care should be taken to avoid applying excessive stem force in backseating.

## 4.0 VALVE / MANIFOLD MAINTENANCE

- 4.1 The important performance parameters are “pressure boundary integrity”, “actuating force required”, and “internal leak tightness”. Maintenance should logically address the importance of preserving these performance parameters.
- 4.2 Valves which remain in one position for long periods of time may be subject to some loss of operability due to the loss of effective lubricants in threads, aging of packing surface, corrosion of moving parts, or accumulation of harmful solids. In some applications, it may be desirable to schedule periodic partial or full cycle operation of those valves.
- 4.3 Pressure-Core™ and O-Ring Stem Seals require no adjustment and are not field serviceable. Should leakage occur, the entire bonnet assembly must be replaced.
- 4.4 **Pressure-Core™ and O-Ring Bonnet Assembly Replacement Instructions**

**CAUTION**

**REMOVE ALL PRESSURE FROM  
THE VALVE BEFORE SERVICING.**

Refer to Section III, beginning on page 5, for BONNET ASSEMBLY REPLACEMENT INSTRUCTIONS.

### 4.5 Soft Seat Replacement Instructions

**CAUTION**

**REMOVE ALL PRESSURE FROM  
THE VALVE BEFORE SERVICING.**

Refer to Section IV, beginning on page 9, for SOFT SEAT REPLACEMENT INSTRUCTIONS.

## 5.0 POST ASSEMBLY INSPECTION

Turn the handle to fully open and close the valve. Check for binding, rubbing or any resistance to smooth operation.

## II. REPLACEMENT PARTS

### A. Manifold Flange Seal Kits

Part Number	Description	Material
P5-018-R0	Manifold Flange Seal	Teflon®
P5-018-R1	Manifold Flange Seal	Grafoil®

### B. .187" Orifices

SEATS	
Part Number	Description
SP3-003-R1	Kel-F® Cone Seat
SP3-003-R2	PEEK® Cone Seat
SP3-003-R3	Teflon® Cone Seat
SP3-003-R4	Delrin® Cone Seat
SP3-003-R9	Tefzel Cone Seat

BONNET ASSEMBLIES			
Part Number	Stem Seal	Seat	Bonnet Material
SAV100CCV	Viton®	Carbide Ball	Carbon Steel
SAV100CCT	Teflon® Pressure-Core™		
SAV100CCJ	Low Temp Teflon® Pressure-Core™		
SAV100SCV	Viton®	Carbide Ball	316 SS
SAV100SCT	Teflon® Pressure-Core™		
SAV100SCJ	Low Temp Teflon® Pressure-Core™		
SAV101C-V	Viton®	Soft Cone	Carbon Steel
SAV101C-T	Teflon® Pressure-Core™		
SAV101C-J	Low Temp Teflon® Pressure-Core™		
SAV101S-V	Viton®	Soft Cone	316 SS
SAV101S-T	Teflon® Pressure-Core™		

### C. .250" Orifices

SEATS	
Part Number	Description
SP3-012-R4	Delrin® Cone Seat
SP3-012-R1	Kel-F® Cone Seat
SP3-012-R2	PEEK® Cone Seat

PRESSURE-CORE™ BONNET ASSEMBLIES			
Part Number	Stem Seal	Seat	Bonnet Material
SAV123C-T-HH	Teflon® Pressure-Core™	Soft Cone	Carbon Steel
SAV123C-J-HH	Low Temp Teflon® Pressure-Core™		
SAV123S-T-HH	Teflon® Pressure-Core™	Soft Cone	316 SS
SAV123S-J-HH	Low Temp Teflon® Pressure-Core™		

# III. HARD SEAT BONNET REPLACEMENT INSTRUCTIONS

.187 AND .250 ORIFICE VALVES WITH  
PRESSURE-CORE™ or O-RING STEM SEAL

## HARD SEAT OPTION

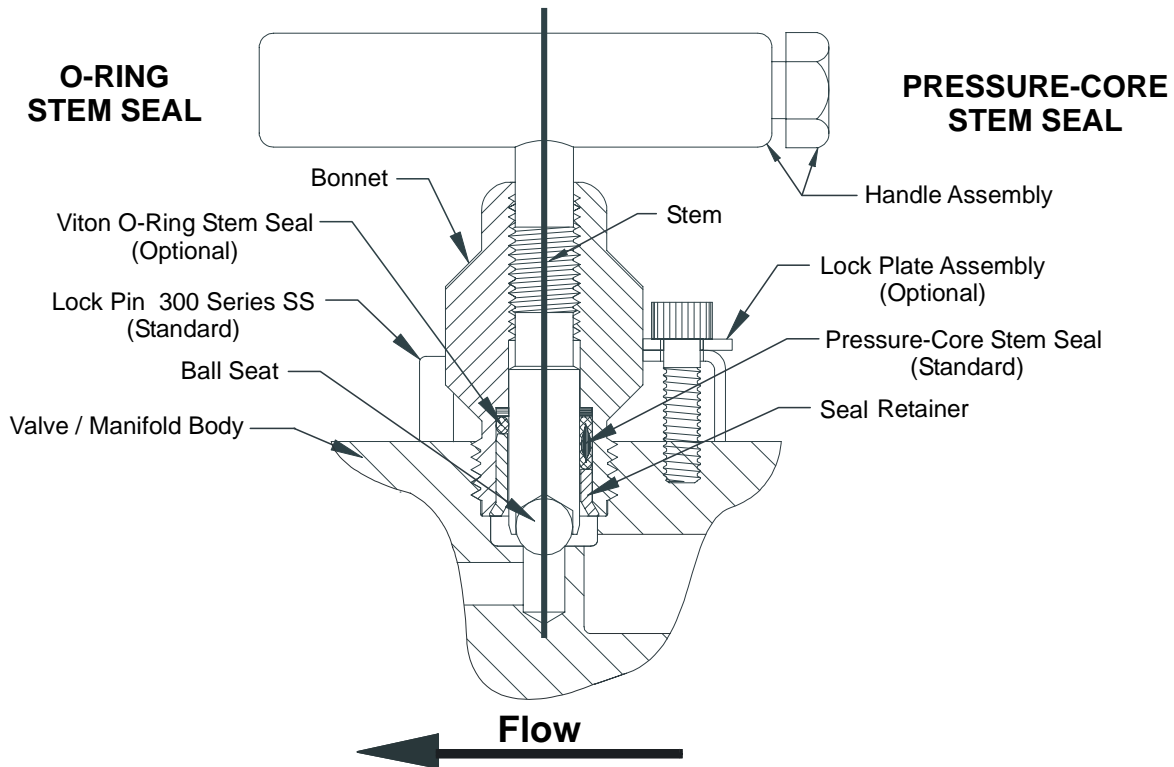

# III. HARD SEAT BONNET REPLACEMENT INSTRUCTIONS

## CAUTION

Remove all pressure from the valve or manifold before servicing. Failure to do so could result in serious injury or death.

**NOTE:** Pressure-Core™ and O-Ring Stem Seals require no adjustment and are not field serviceable. Should leakage occur, the entire Bonnet Assembly must be replaced.

<b>Tools Needed:</b> 3/4" Open-End Wrench	9/64" Allen wrench	Vise Grips
Small, Flat Blade Screwdriver	1/4" Punch	Hammer

1. After removing all pressure from the valve or manifold, turn the Handle Assembly counter-clockwise until the valve is fully open. This **MUST** be done prior to bonnet assembly and disassembly.

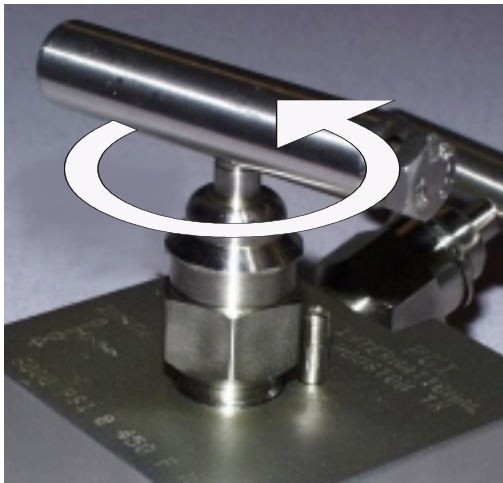

2. Place the Vise Grips over the Lock Pin, as shown, and pull the pin upward while rocking the pin back and forth.

## IMPORTANT

The used Lock Pin must be discarded.



3. Place the 3/4" open-end wrench on the Bonnet Body and remove the Bonnet Assembly from the valve/manifold by turning counter-clockwise.



### III. HARD SEAT BONNET REPLACEMENT INSTRUCTIONS

4. Clean and inspect the threads on the replacement Bonnet Assembly and inside the valve/manifold seat pocket.

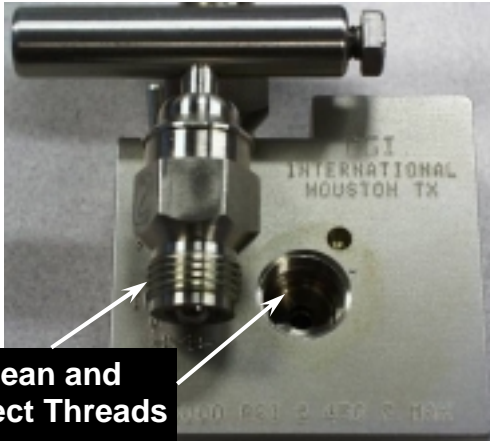

**Clean and Inspect Threads**

#### **CAUTION**

If the Bonnet or seat pocket threads appear damaged or corroded, DO NOT try to repair the valve or put it back in service.

5. **CAUTION**

Make sure the stem of the replacement Bonnet Assembly is fully opened (turned counter-clockwise) prior to installation to your valve/manifold. Failure to do so could damage the seat and/or the bonnet.

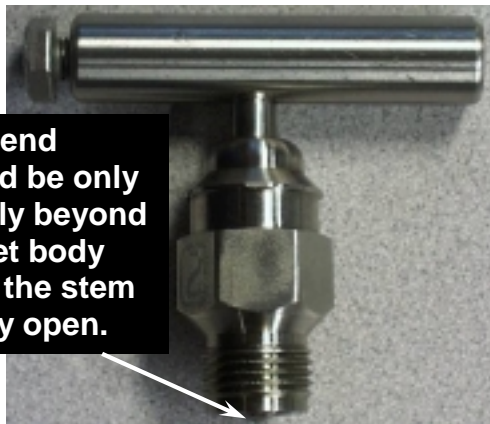

**Stem end should be only slightly beyond bonnet body when the stem is fully open.**

6. Lightly lubricate the replacement Bonnet threads with a Nickel-based Anti-Seize.

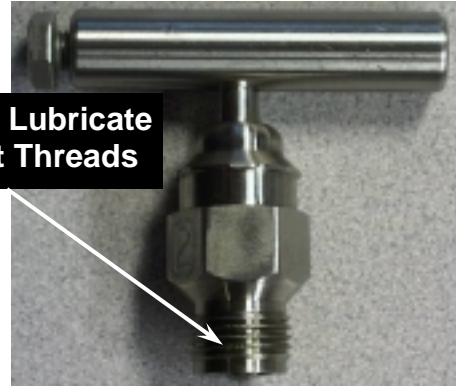

**Lightly Lubricate Bonnet Threads**

7. Install the replacement Bonnet Assembly into the valve/manifold and torque to 30/35 ft.-lbs.

See NOTE below for torque approximation

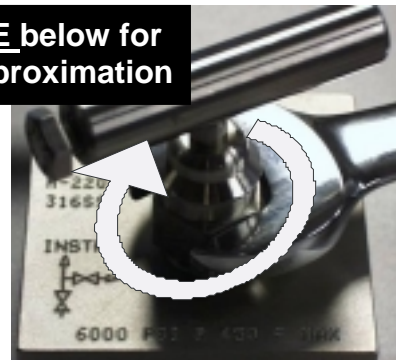

As you approach the desired torque, align one of the hex flats on the Bonnet Body to permit the Lock Pin to be installed.

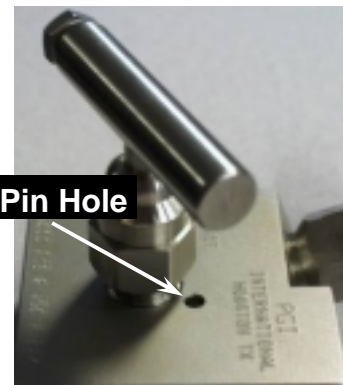

**Lock Pin Hole**

#### **NOTE**

A solid pull-down with a 6" long, open-end wrench by hand, with no cheater devices, will approximate the required torque.

### III. HARD SEAT BONNET REPLACEMENT INSTRUCTIONS

---

8. Turn the Handle Assembly clockwise until the valve is fully closed; hand-tight only.



9. Pressurize the system and check for leaks. If leakage appears around the seat pocket, be sure the Bonnet Assembly has been tightened to 30/35 ft.-lbs.
10. Once no leakage is detected, insert a new Lock Pin into the Lock Pin Hole and, using the 1/4" punch and hammer, drive the Pin to the bottom of the hole.

**IMPORTANT!**

**Never reuse an old Lock Pin.**

**Be sure the Lock Pin is driven to the bottom of the hole.**

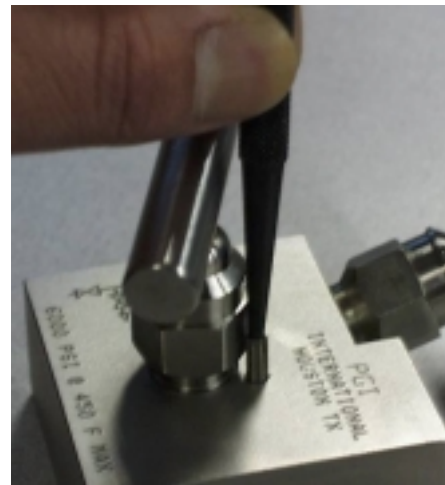

11. Your valve/manifold is now ready for normal operation. Place the Stem in the desired operating position.



# IV. SOFT SEAT & BONNET REPLACEMENT INSTRUCTIONS

.187 AND .250 ORIFICE VALVES WITH  
PRESSURE-CORE™ or O-RING STEM SEAL

## SOFT SEAT OPTION

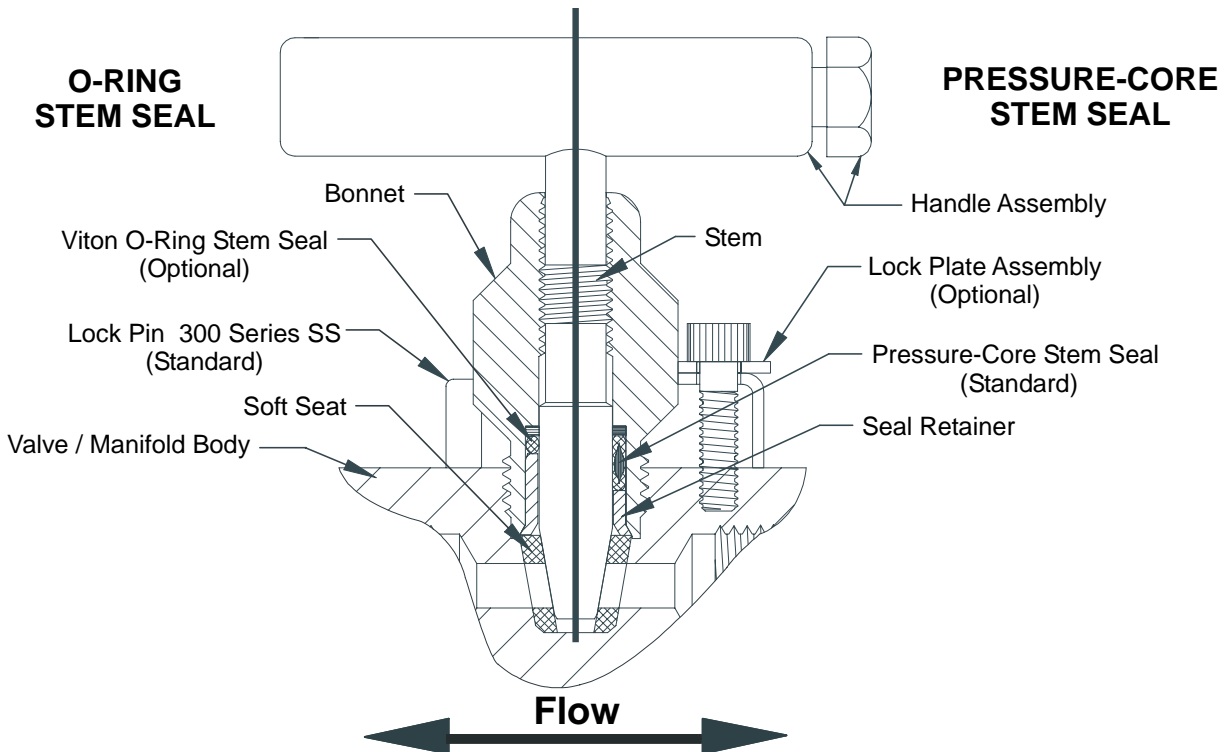

## IV. SOFT SEAT & BONNET REPLACEMENT INSTRUCTIONS

### CAUTION

Remove all pressure from the valve or manifold before servicing. Failure to do so could result in serious injury or death.

**NOTE:** Pressure-Core™ and O-Ring Stem Seals require no adjustment and are not field serviceable. Should leakage occur, the entire Bonnet Assembly must be replaced.

<b>Tools Needed:</b> 3/4" Open-End Wrench	9/64" Allen wrench	Vise Grips
Small, Flat Blade Screwdriver	1/4" Punch	Hammer

1. After removing all pressure from the valve or manifold, turn the Handle Assembly counter-clockwise until the valve is fully open. This **MUST** be done prior to bonnet assembly and disassembly.

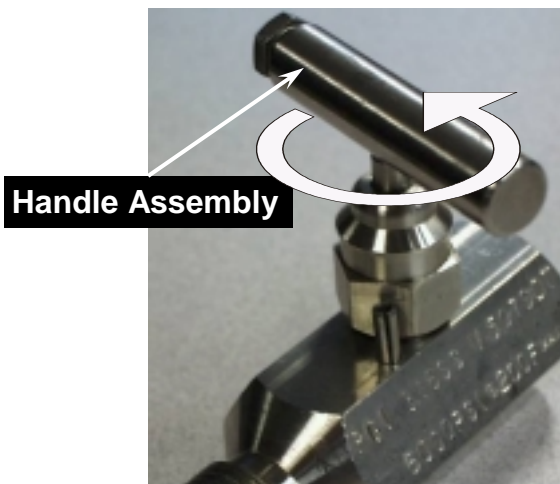

2. Place the Vise Grips over the Lock Pin, as shown, and pull the pin upward while rocking the pin back and forth.

### IMPORTANT

The used Lock Pin must be discarded.



3. Place the 3/4" open-end wrench on the Bonnet Body and remove the Bonnet Assembly from the valve/manifold by turning counter-clockwise.



# IV. SOFT SEAT & BONNET REPLACEMENT INSTRUCTIONS

**4. Each time the Bonnet Assembly is replaced, it is mandatory to inspect the condition of the cone seat.**

5. To inspect the cone seat, place an Allen Wrench (or a small screwdriver) into the through hole, as shown below, and strike the wrench with the palm of your hand, as indicated.

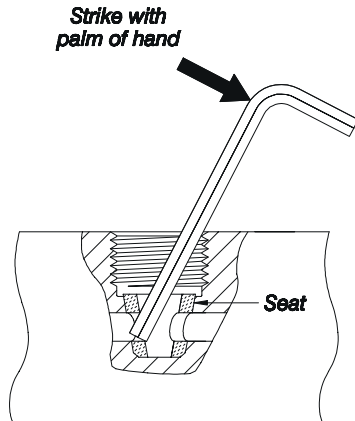

6. Clean and inspect the seat pocket and threads in the valve/manifold body and on the Bonnet Assembly.

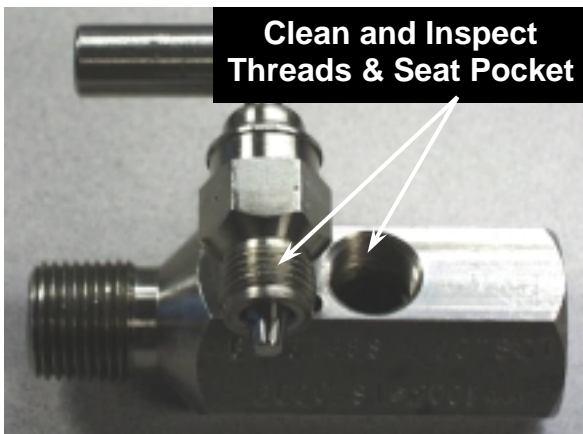

## CAUTION

If the Bonnet or seat pocket threads appear damaged or corroded, DO NOT try to repair the valve or put it back in service.

7. Inspect the cone seat for gouges, scratches, etc.

To minimize downtime, any seats showing signs of wear and tear should be replaced.

8. Lightly lubricate the cone seat to be installed with a silicone based lubricant.

9. Align the through holes in the cone seat with the line of flow in the valve or manifold body and guide seat into the Pocket with an Allen Wrench or small screwdriver.

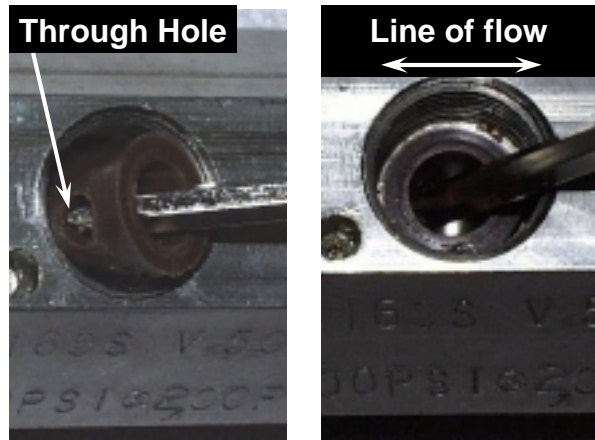

10. Once the cone seat is aligned with the line of flow, use the tip of your finger to press the seat downward.

**DO NOT USE HARD OBJECTS TO DRIVE THE SEAT DOWNWARD.**

The use of such objects may cause damage to the pocket seal surface.

The cone seat will become fully seated when the Bonnet Assembly is installed to the valve/manifold.

## IV. SOFT SEAT & BONNET REPLACEMENT INSTRUCTIONS

11. Make sure the Bonnet Assembly to be installed is in the “OPEN” position prior to installation (turned counter-clockwise).

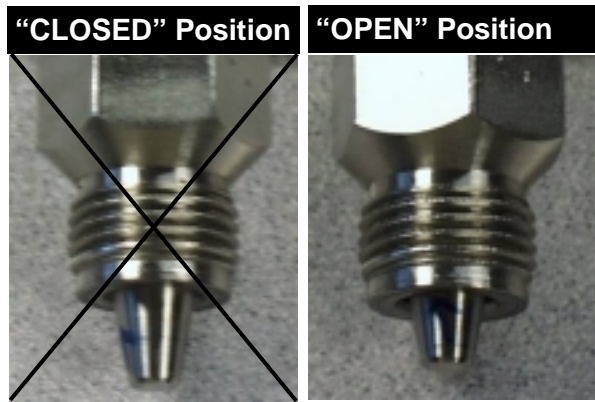

12. Lightly lubricate the Bonnet threads and the Seal Lip with Nickel-based Anti-Seize.

Lubricate Threads and Seal Lip

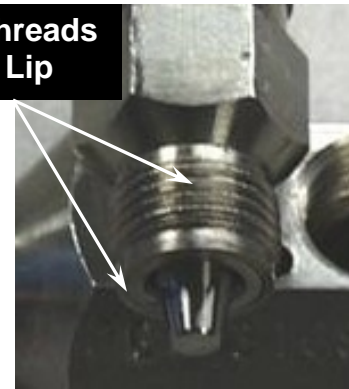

13. Install the Bonnet Assembly into the valve/manifold and torque to 30/35 ft.-lbs.

See NOTE below for torque approximation



As you approach the desired torque, align one of the hex flats on the Bonnet Body to permit the Lock Pin to be installed.

Lock Pin Hole

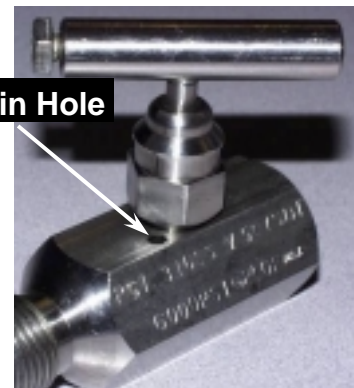

### NOTE

A solid pull-down with a 6” long, open-end wrench by hand, with no cheater devices, will approximate the required torque.

## IV. SOFT SEAT & BONNET REPLACEMENT INSTRUCTIONS

---

14. Turn the Handle Assembly clockwise until the valve is fully closed; hand-tight only.

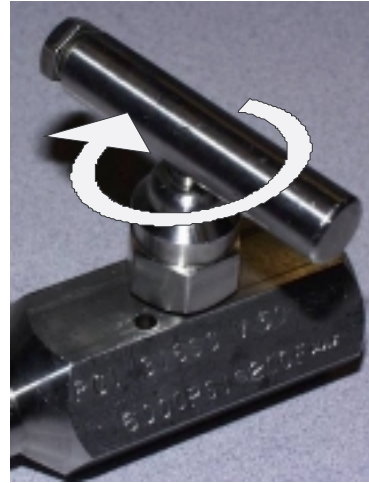

15. Pressurize the system and check for leaks. If leakage appears around the seat pocket, be sure the Bonnet Assembly has been tightened to 30/35 ft.-lbs.
16. Once no leakage is detected, insert a new Lock Pin into the Lock Pin Hole and, using the 1/4" punch and hammer, drive the Pin to the bottom of the hole.

### **IMPORTANT!**

**Never reuse an old Lock Pin.**

**Be sure the Lock Pin is driven to the bottom of the hole.**



17. Your valve/manifold is now ready for normal operation. Place the Stem in the desired operating position.