



I. O. & M. Manual

Installation

Operation

Maintenance

**.187 Orifice Valves and Manifolds
with Three-Piece Style,
Packed (Adjustable) Bonnets**

Form IOM-VM187PKD, Revision 02
Jan. 2005

PGI International

Excellence Through Innovation

16101 Vallen Drive Houston, Texas 77041

(713) 466-0056 (800) 231-0233 Fax: (800) 568-9228

I. I. O. & M. INSTRUCTIONS

For .187 Orifice Valves and Manifolds with Three-Piece Style, Packed (Adjustable) Bonnets

1.0 INTRODUCTION

This valve/manifold is supplied with either a soft seat or a hard seat sealing option. The packing is field adjustable and positioned below the stem threads for long service life.

2.0 INSTALLATION

2.1 Remove the valve/manifold from the shipping box and check the body stamping for correct part or identification number.

2.2 Prior to valve/manifold installation, check the piping to which the valve or manifold is to be connected for cleanliness and remove any foreign debris.

2.3 Thread Valve Installation

2.3.1 All pipe or fitting connections must be made tight. NPT pipe joints depend on a good, smooth engagement between the male and female pipe threads, usually with the use of a thread sealant. Typically, Grafoil tape is used in high temperature applications. For low temperature applications, Teflon tape or other standard pipe thread sealants may be used.

2.3.2 Check the threads on both the valve/manifold and the mating pipe for cleanliness.

2.3.3 Do not use excessive wrenching force on an NPT pipe joint. Refer to the chart below for the proper torque for your NPT pipe connection fitting.

PIPE OR TUBE ANSI/ASME B1.20.1 NOMINAL INCH	TIGHTENING TORQUE		
	INCH-POUNDS IN-LBS	FOOT-POUNDS FT-LBS	METER-NEWTONS M-N
1/4	600	50	68
3/8	700	58	79
1/2	850	71	96
3/4	1,000	83	113
1	1,200	100	136

3.0 OPERATION

3.1 Hand valves which have been reasonably matched to a typical service application and properly installed in its piping system can be expected to have a long service life with minimum attention. However, valves have moving and wearing parts and depend on long term preservation of highly finished surfaces on the stem, the ball and the bonnet body for satisfactory performance.

3.2 The handle of the valve has been designed to provide an adequate seating force to seal the valve against the maximum pressure of the valve without the use of additional mechanical advantage. The use of a "cheater" to operate the valve is **not necessary, not recommended, and can cause valve damage.**

3.3 All valves have rising stems with right-hand thread. Rotate the handle counter-clockwise to open and clockwise to close.

I. I. O. & M. INSTRUCTIONS

3.0 OPERATION (cont'd)

- 3.4 Valves with rising stems are provided with a backseat. The backseat is a shoulder on the stem or other part of the stem-disk assembly which engages a corresponding seat shoulder on the inner side of the bonnet.

It has become generally recognized that the use of the stem backseat for stem sealing may mask unsatisfactory condition of the stem seal. For this reason, the use of the backseat for normal operation stem sealing is NOT recommended. The backseat in rising stem valves should be regarded simply as a “stop” to prevent overtravel when opening the valves. Normal practice should be to unseat the backseat slightly.

If it is necessary to use the backseat for stem sealing, it should be recognized that backseats are usually smaller than the main seat and care should be taken to avoid applying excessive stem force in backseating.

4.0 VALVE / MANIFOLD MAINTENANCE

- 4.1 The important performance parameters are “pressure boundary integrity”, “actuating force required”, and “internal leak tightness”. Maintenance should logically address the importance of preserving these performance parameters.
- 4.2 Valves which remain in one position for long periods of time may be subject to some loss of operability due to the loss of effective lubricants in threads, aging of packing surface, corrosion of moving parts, or accumulation of harmful solids. In some applications, it may be desirable to schedule periodic partial or full cycle operation of those valves.
- 4.3 Stem seal leakage usually results from seal wear and can usually be corrected by replacing or adjusting the stem seal.
- 4.4 Stem Packing Adjustment**
NOTE: This operation may be performed safely with the valve under full line pressure. Refer to Section II on page 5, for PACKING ADJUSTMENT INSTRUCTIONS.
- 4.5 Adding Stem Seal Packing**

CAUTION
**REMOVE ALL PRESSURE FROM
THE VALVE BEFORE SERVICING.**

Refer to Section III beginning on page 6,
for ADDING STEM SEAL PACKING INSTRUCTIONS.

5.0 POST ASSEMBLY INSPECTION

Turn the handle to fully open and close the valve. Check for binding, rubbing or any resistance to smooth operation.

I. I. O. & M. INSTRUCTIONS

.187 ORIFICE PACKED BALL SEAT VALVE

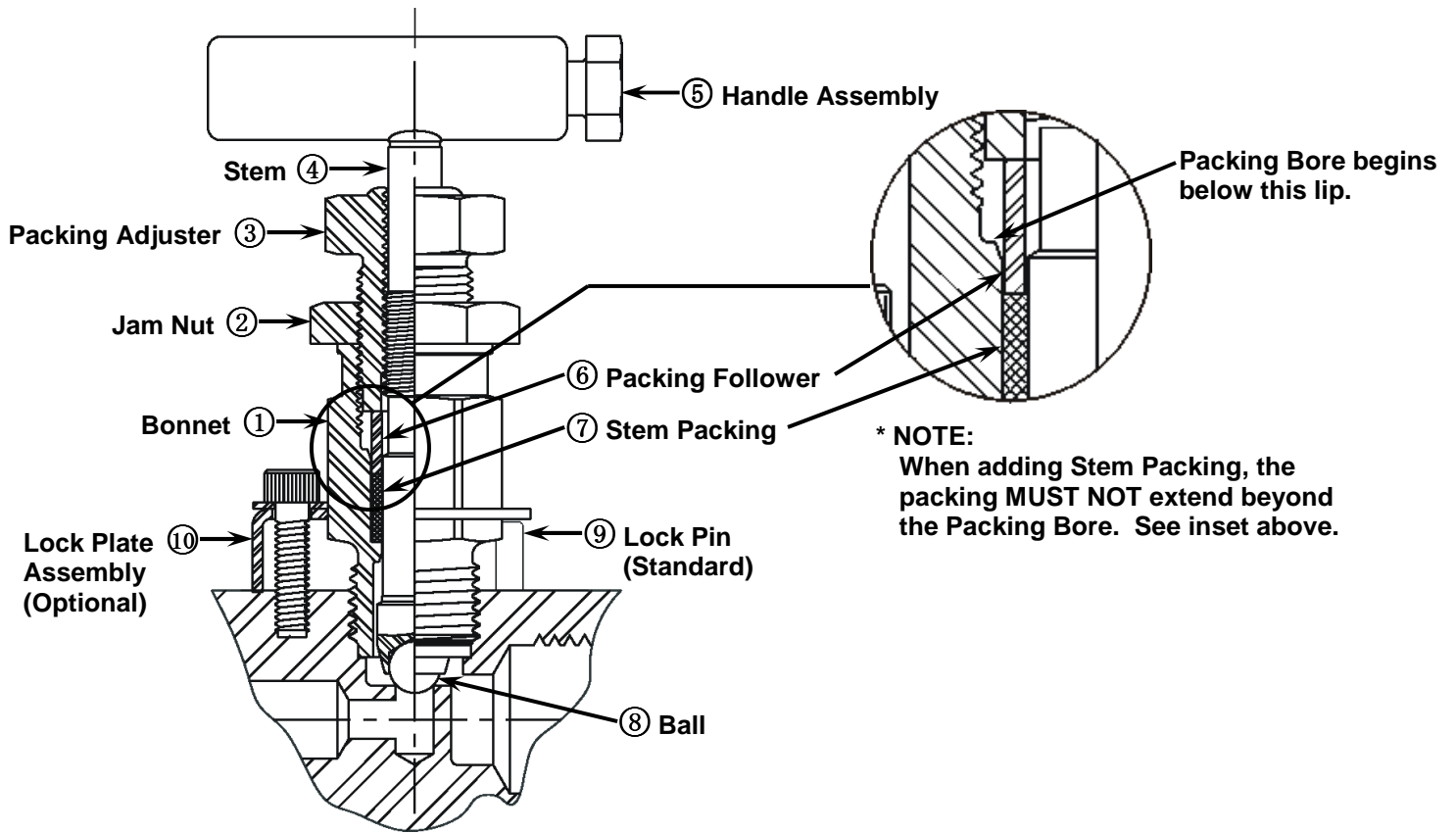

FIGURE 1

VALVE/MANIFOLD MAINTENANCE

PACKING	PART NUMBER	QTY. PER BONNET
Teflon	P5-292-R0	1 required
Grafoil	P5-025-R0	1 or 2 required (See *Note above.)

MANIFOLDS ONLY

FLANGE SEALS	PART NUMBER	QTY. PER MANIFOLD
Teflon	P5-018-R0	1 per Pressure Manifold
Grafoil	P5-018-R1	2 per ΔP Manifold

II. PACKING ADJUSTMENT INSTRUCTIONS

NOTE: The stem packing adjustment can be performed safely while the valve or manifold is under full line pressure. Refer to Figure 1 for corresponding part names and numbers.

Tools Needed:

3/4" Open-End wrench, 11/16" Open-End wrench, 5/8" Open-End Wrench

1. Turn the Handle Assembly counter-clockwise until the valve is fully open. This **MUST** be done prior to adjusting the packing.

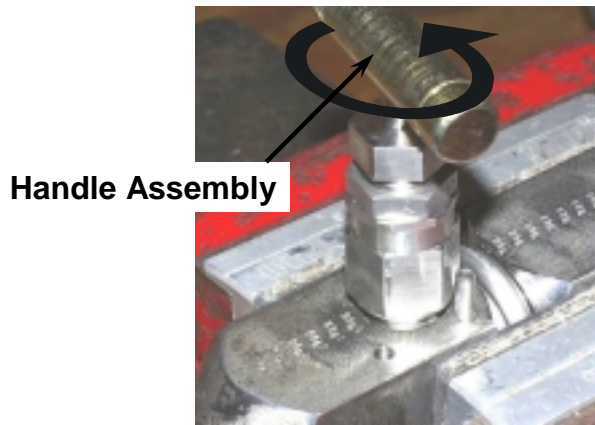

2. Loosen Jam Nut with the 11/16" open-end wrench by turning it counter-clockwise.

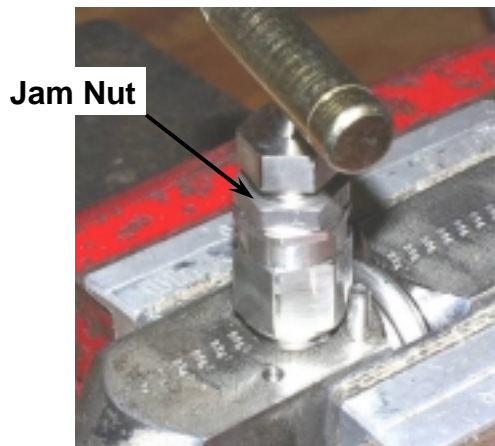

3. Using the 5/8" open-end wrench, tighten the Packing Adjuster by turning it clockwise 1/8 turn at a time, until the leak is corrected.

Once the leak has been corrected, do not tighten the Packing Adjuster any further.

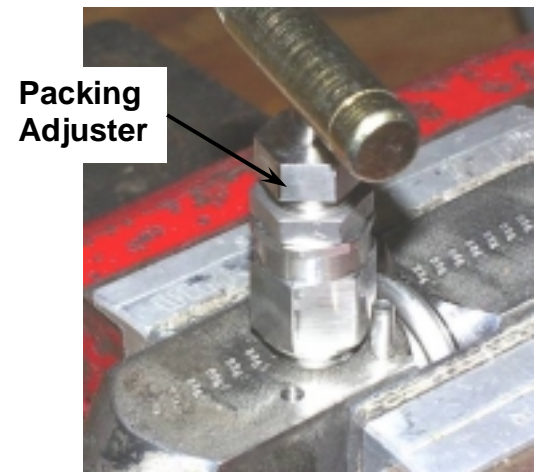

CAUTION

If the Packing Adjuster will not turn with reasonable force, it has become bottomed out and the Stem Packing (Item 7 in Fig. 1) must be replaced. See Section III on page 6, for ADDING STEM SEAL PACKING INSTRUCTIONS.

4. Re-tighten the Jam Nut snug with the 11/16" open-end wrench.
5. Operate the Stem from fully open to fully closed, to ensure that the leak has been corrected.
6. Your valve/manifold is now ready for normal operation. Place the Stem in the desired operating position.

III. ADDING STEM SEAL PACKING INSTRUCTIONS

CAUTION!

Remove all pressure from the valve or manifold before servicing.
Failure to do so could result in serious injury or death.

Tools Needed: 3/4" Open-End Wrench, 11/16" Open-End Wrench, 5/8" Open-End Wrench, 7/16" Open-End Wrench, 9/64" Allen Wrench, Pliers, Flat Blade Screwdriver, 1/4" Punch

NOTE: Refer to Figure 1, for corresponding part names.

1. After removing all pressure from the valve or manifold, turn the Handle Assembly counter-clockwise until the valve is fully open. This **MUST** be done prior to bonnet assembly and disassembly.

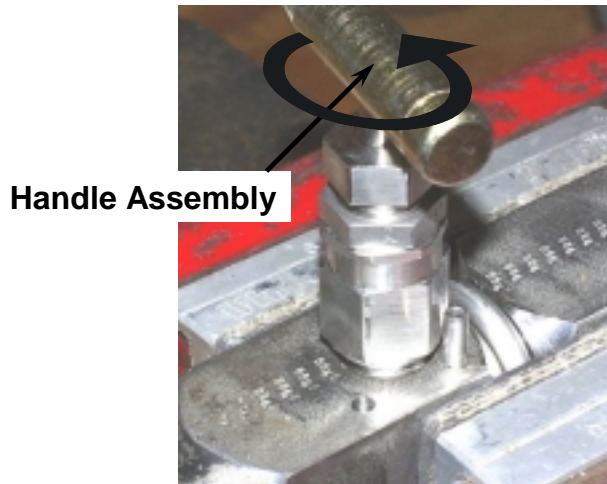

2. Loosen the Jam Nut with the 7/8" open-end wrench.

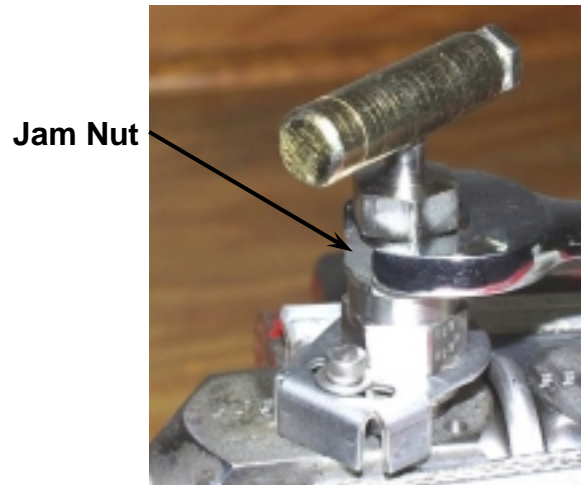

3. Remove the Allen screw from the Lock Plate Assembly using the 9/64" Allen wrench, or, if there is no Lock Plate, remove the Lock Pin using the pliers.



Remove
Allen Screw

or

Remove
Lock Pin

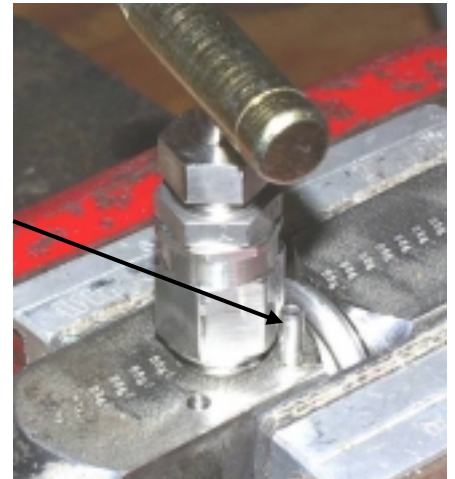

IMPORTANT

The used Lock Pin
(Item 9 in Fig. 1)
must be discarded.

III. ADDING STEM SEAL PACKING INSTRUCTIONS

- Place the 3/4" open-end wrench on the Bonnet Body and remove the Bonnet Assembly from the valve/manifold by turning counter-clockwise.

Bonnet Body



- Clean and inspect the threads on the Bonnet and inside the valve/manifold seat pocket.

CAUTION

If the Bonnet or seat pocket threads appear damaged or corroded, DO NOT try to repair the valve or put it back in service.

Clean and Inspect Threads



NOTE

If the entire Bonnet Assembly is being replaced, GO TO STEP #16.
If only the packing is being added, using the existing Bonnet Assembly, continue to step #6.

- Using a 7/16" open-end wrench, remove the Handle Assembly from the Stem by loosening the hex head bolt four full turns and pulling the Handle Assembly off. It may be necessary to tap the handle lightly to break it away from the Stem.

Handle Assembly

Stem



III. ADDING STEM SEAL PACKING INSTRUCTIONS

7. Turn the top of the Stem clockwise until it can be turned by the Ball end at the bottom of the Bonnet Body, then turn the Ball end of the Stem counter-clockwise until it can be removed from the bottom of the Bonnet Body.



8. Using the 5/8" open-end wrench, turn the Packing Adjuster counter-clockwise until it is completely disengaged from the Bonnet Body.



9. Using the flat blade screwdriver, push the Packing Follower out of the Bonnet cavity.

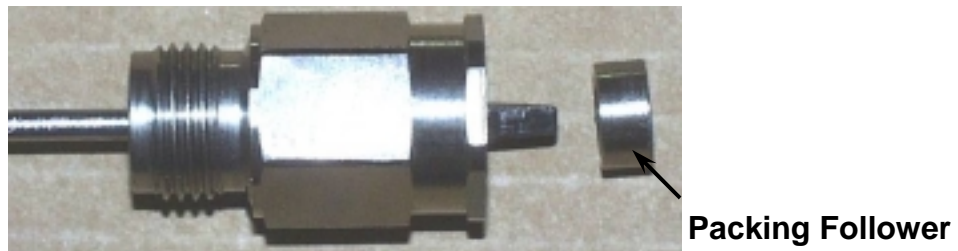

10. Inspect the seal surface on the Stem for scratches and gouges. Replace the entire Bonnet Assembly if scratches or gouges are present.



III. ADDING STEM SEAL PACKING INSTRUCTIONS

11. Insert new Stem Packing (Item 7 in Fig. 1) into the Bonnet Body.

Teflon Packed—1 ring required

Grafoil Packed—1 or 2 rings required

See Valves and Manifolds Chart on page 4, for Packing Part Numbers.

Make sure the Packing Rings lie flat and below the larger bore in the Bonnet Body. (See Figure 1 inset.)



Stem Packing Ring

Packing Bore begins below this lip.

12. Insert the Packing Follower on top of the Stem Packing.

Packing Follower

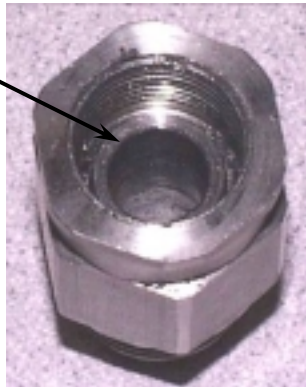

13. Lightly lubricate the Packing Adjuster threads only with Nickel Anti-Seize 2400°F and re-install the Packing Adjuster into the top of the Bonnet just until it stops against the Packing Follower, **then** loosen 1/2 turn.

Lubricate Packing Adjuster Threads Only

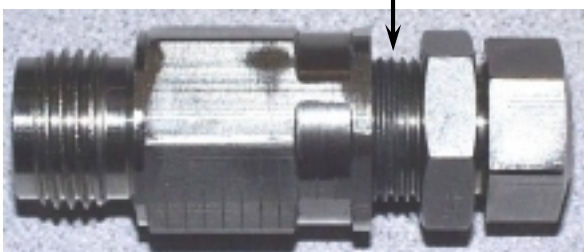

14. Lightly lubricate the Stem threads only with Nickel Anti-Seize 2400°F and re-install the Stem from the bottom of the Bonnet.

Lubricate Stem Threads Only

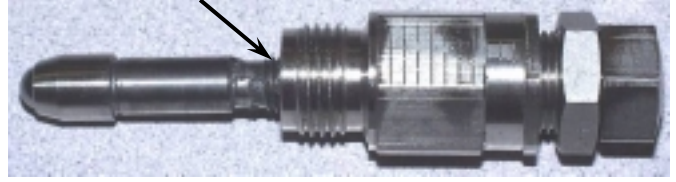

15. From the bottom of the Bonnet Body (as shown above), turn the Stem into the Bonnet Body **clockwise** as far as possible using your fingertips. Align the flat on the Stem with the Hex Head Bolt in the Handle Assembly and re-install the Handle. Tighten with the 7/16" open-end wrench.

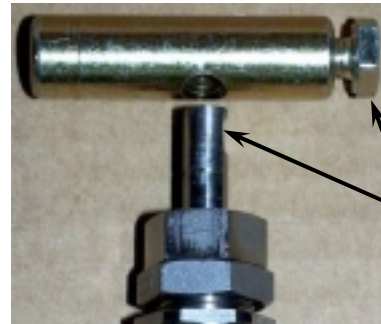

Align Flat with Hex Head Bolt

16. Turn the Handle **counter-clockwise** until you feel the Stem backseat against the Bonnet. The Ball (Item 8 in Fig.1) is now in the "full up" position.



WARNING!

Make sure the Ball is in the "full up" position, as shown. Failure to do so could damage the seat and/or the Bonnet.

III. ADDING STEM SEAL PACKING INSTRUCTIONS

17. Lightly lubricate the Bonnet threads with Nickel Anti-Seize 2400°F.

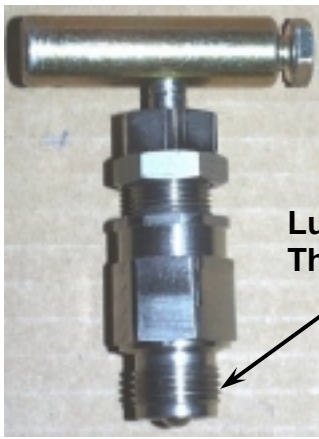

Lubricate Bonnet Threads Only

18. If your valve/manifold is outfitted for a Lock Plate, slip it all the way up to the top of the Bonnet Body at this time.

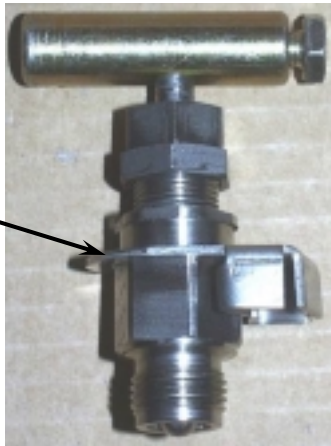

Lock Plate

If your valve/manifold is not outfitted for a Lock Plate, go to step 26b.

19. Hold the Lock Plate at the top of the Bonnet while turning the Bonnet Assembly into the valve/manifold body with your fingertips.

DO NOT TURN THE HANDLE TO INSTALL THE BONNET.



20. Once the Bonnet makes contact with the valve/manifold, allow the Lock Plate to fall to the bottom of the Bonnet and tighten the Bonnet Body to 35 ft.-lbs., using the 3/4" open-end wrench.

Bonnet

See NOTE below for torque approximation

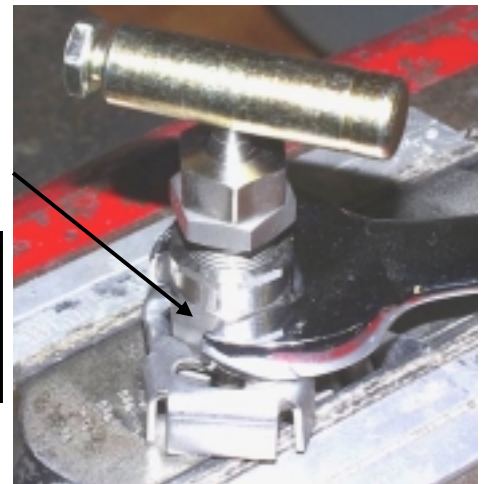

NOTE

A solid pull-down with a 6" long, open-end wrench by hand, with no cheater devices, will approximate the required torque.

III. ADDING STEM SEAL PACKING INSTRUCTIONS

21. a) Teflon Packed Bonnets

Tighten the Packing Adjuster finger-tight, then tighten 1/2 turn with the 5/8" open-end wrench.

Note: The Stem should now have a smooth, firm operating feel.

b) Grafoil Packed Bonnets

Tighten the Packing Adjuster finger-tight, then tighten 1-1/2 turns with the 5/8" open-end wrench.



22. Turn the Handle Assembly clockwise until fully closed; hand-tight only.

Handle Assembly



23. Pressurize the system and check for leaks.

Note: If leakage appears around the pocket, make sure the Bonnet Body has been tightened to 35 ft.-lbs.



Bonnet Body

If leakage appears in this area, tighten Bonnet Body to 35 ft.-lbs.

Note: If leakage appears in the upper portion of the Bonnet Assembly, turn the Packing Adjuster clockwise 1/8 turn at a time, until the leak is corrected.

DO NOT TIGHTEN MORE THAN 1/8 TURN PAST THE POINT WHERE THE LEAK STOPPED.

Over tightening will use up valuable packing range adjustments.

Packing Adjuster

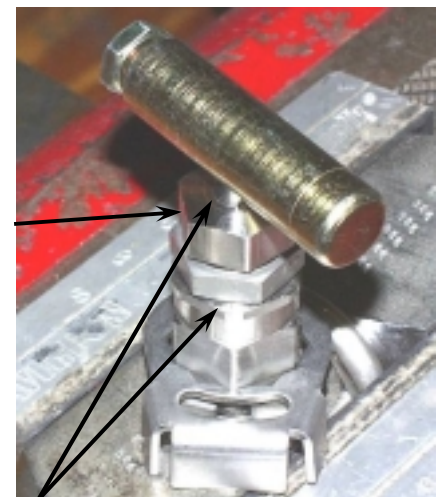

If leakage appears in either of these areas, turn the Packing Adjuster 1/8 turn until the leak is corrected.

III. ADDING STEM SEAL PACKING INSTRUCTIONS

24. Once no leakage is detected, tighten the Jam Nut snug with the 11/16" open-end wrench.

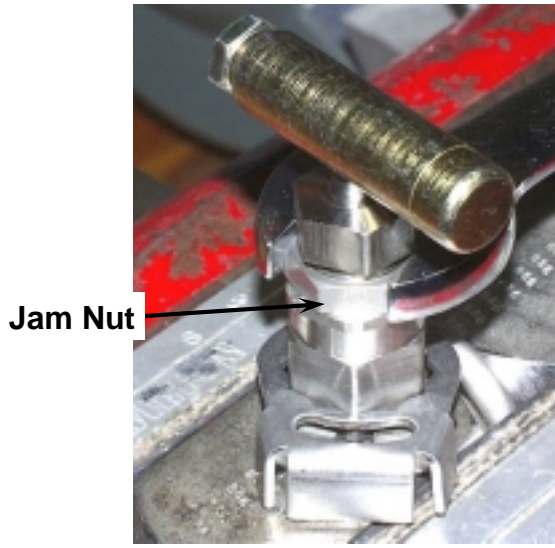

25. Lift the Lock Plate and locate the threaded lock screw hole.

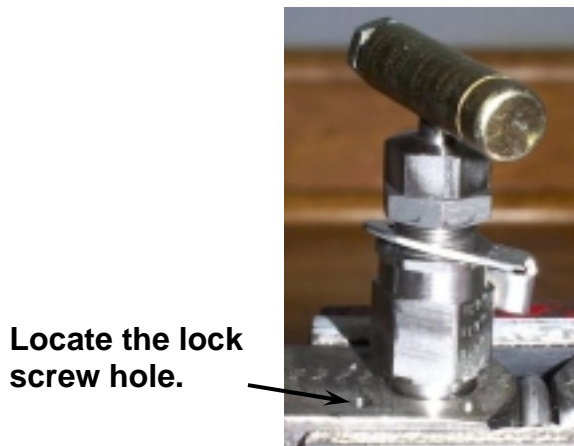

If your valve/manifold is not outfitted for a Lock Plate, go to step 26b.

26. a) Orient the Lock Plate so that the Lock Screw Hole is accessible through the cut-out and allow the Lock Plate to fall to the valve/manifold body.

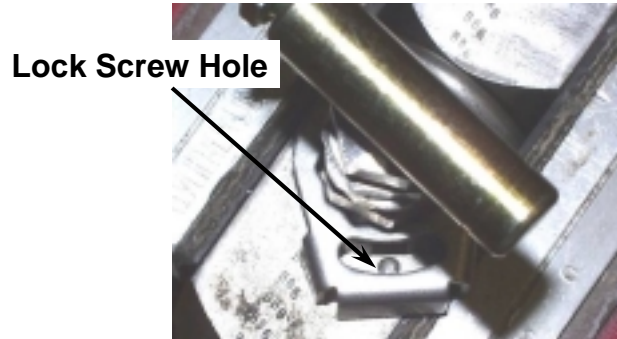

- b) If your valve/manifold is not outfitted for a Lock Plate, the Lock Pin Hole must be accessible to install the Lock Pin. If the Lock Pin Hole is obstructed, turn the Bonnet Assembly clockwise until the Lock Pin may be installed.

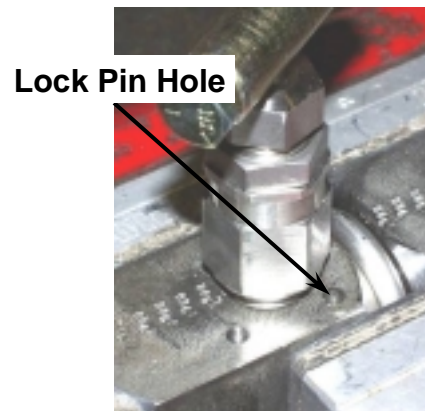

WARNING!

Never loosen the Bonnet Assembly to gain access to the Lock Pin Hole.

III. ADDING STEM SEAL PACKING INSTRUCTIONS

27. a) Insert the Lock Screw and tighten with the 9/64" Allen wrench.

OR,

b) Insert a new Lock Pin into the Lock Pin Hole and, using the 1/4" punch, drive the Pin to the bottom of the hole.

Lock Screw



New Lock Pin

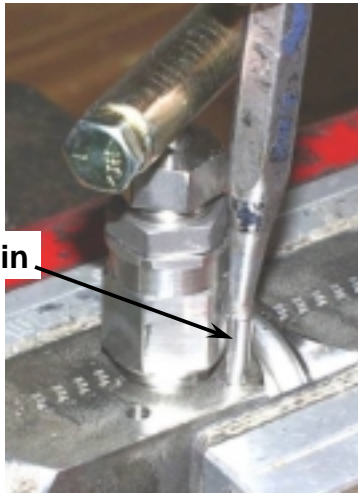

IMPORTANT!

**Never reuse an old Lock Pin.
Be sure the Lock Pin is driven to the
bottom of the hole.**

28. Your valve/manifold is now ready for normal operation. Place the Stem in the desired operating position.