



PGI International, Ltd.
Excellence Through Innovation

16101 Vallen Drive—Houston, Texas 77041
(713) 466-0056 or (800) 231-0233
www.pgiint.com



I. O. & M. Manual

Installation

Operation

Maintenance

Rod-Out Device with Adjustable Packing (AK-132)

Form IOM-RodOut, Revision 03
May 2009

PGI International
Excellence Through Innovation

16101 Vallen Drive Houston, Texas 77041
(713) 466-0056 (800) 231-0233 Fax: (800) 568-9228

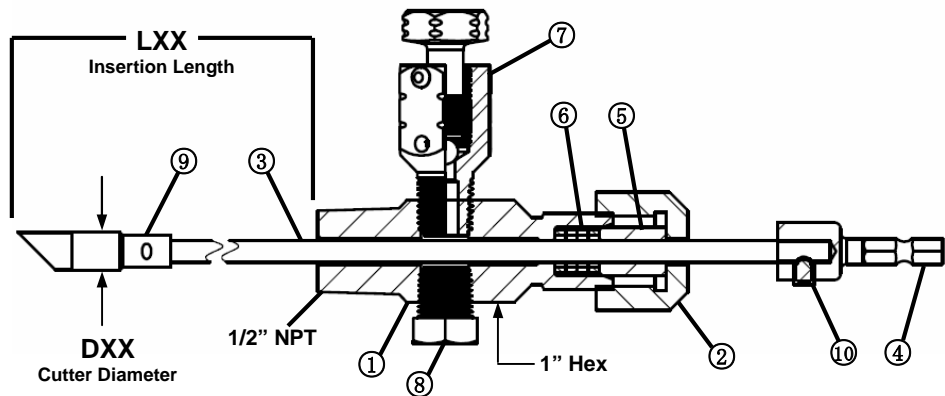

Figure 1

Product Part Number →	AK-132SG-DXXLXX	AK-132ST-DXXLXX
Pressure and Temperature →	1200 psi @ 1000°F Max.	1500 psi @ 450°F Max.

Item Number	Description	Materials	
1	Rod Out Body	316 SS	316 SS
2	Packing Adjuster (1" Hex)	300 Series SS	300 Series SS
3	Rod	17-4 Ph	17-4 Ph
4	Drive Connector (1/4" Hex)	316 SS	316 SS
5	Packing Follower	316 SS	316 SS
6	Packing (4 rings required)	Grafoil 267FTK	Teflon®
7	1/4" NPT Vent Plug Assembly	316 SS/Tungsten Carbide	316 SS/Tungsten Carbide
8	1/4" NPT Pipe Plug	316 SS	316 SS
9	Cutter (3/8" Dia.)	17-4 Ph	17-4 Ph
10	Set Screw (3/32" Hex Socket)	300 Series SS	300 Series SS

Packing Kit Number	Includes:
SAK-132-C0-G21	4 Grafoil 267FTK Packing Rings
SAK-132-C0-T21	4 Teflon® Packing Rings

5.5 The cavity may not accept all four Packing Rings ⑥ from the service kit. Add only the number of Packing Rings it takes to fill the cavity, but also allows the Packing Follower ⑤ to be partially inserted into the Body.

NOTE: The Packing Rings will fit very loosely over the Rod and into the cavity. The seal will be created as the Packing Adjuster is tightened.

NOTE: See chart on page 2 of this manual for Part Numbers and O-Ring materials.

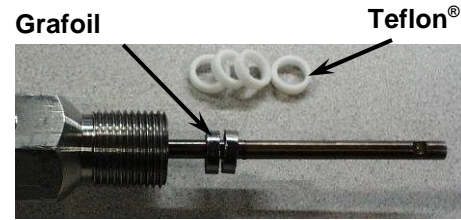

5.6 With the flat end toward the Packing, place the Packing Follower ⑤ onto the Rod and into the cavity.

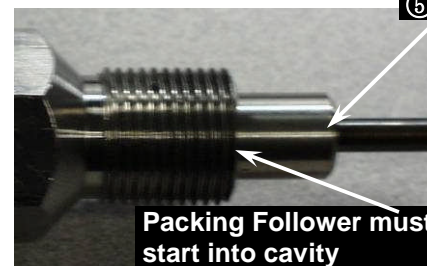
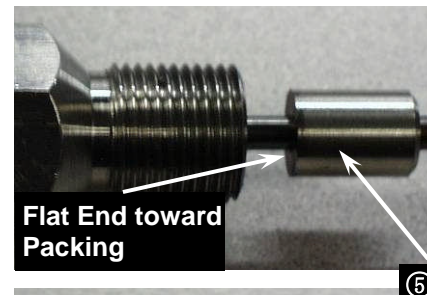

5.7 Place the Packing Adjuster ② over the end of the Rod and screw onto the Body hand-tight.

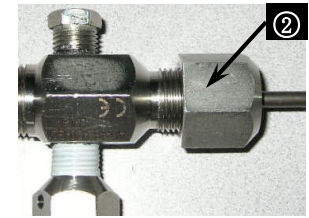

5.8 Align the Set Screw ⑩ with the flat on the Rod and re-install the Drive Connector. Tighten with a 3/32" Allen wrench.

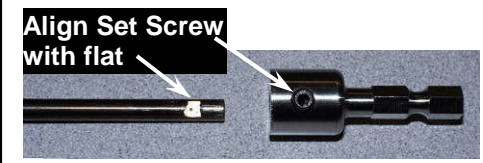

5.9 Grasp the Connector ④ with your fingertips and spin the Rod back and forth while tightening the Packing Adjuster ② until the Rod can no longer be turned by hand.

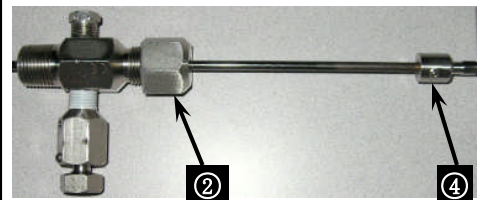

5.10 Close the Vent Plug Stem.

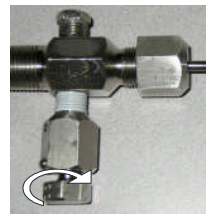

5.11 Pressurize the Rod-Out and check for leaks. If a leak is detected, tighten the Packing Adjuster in 1/8 turn increments until the leak is corrected, as shown on page 4 of this manual.

5.0 INSTRUCTIONS FOR ADDING PACKING

WARNING! WARNING! WARNING! WARNING! WARNING! WARNING!

REMOVE ALL PRESSURE FROM THE ROD-OUT DEVICE BEFORE SERVICING. FAILURE TO DO SO MAY RESULT IN SERIOUS INJURY OR DEATH.

Tools Needed: 1/2" Hex Wrench*, 3/32" Allen Wrench, 1" Open-End Wrench* (* 8" Adjustable Wrench may be used)

- 5.1 Once pressure to the Rod-Out Device is isolated, using a 1/2" hex wrench, loosen the Vent Plug Stem to relieve any residual pressure.

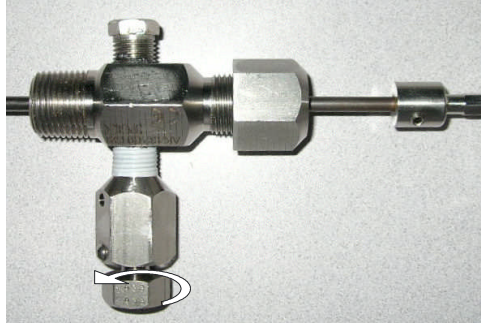

Loosen Vent Plug Stem

- 5.2 Extend the Rod a minimum of six inches from the top of the Packing Adjuster.

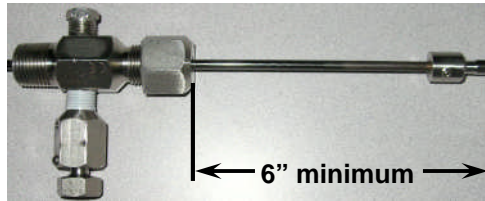

- 5.3 Using a 3/32" Allen wrench, loosen the Set Screw ⑩ and remove the Drive Connector ④.

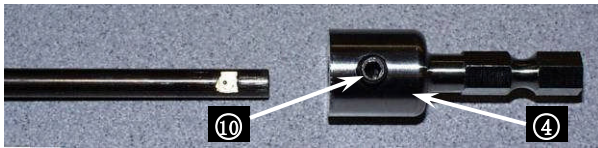

- 5.4 Using a 1" open-end wrench, remove the Packing Adjuster ②. Remove the Packing Follower ⑤.

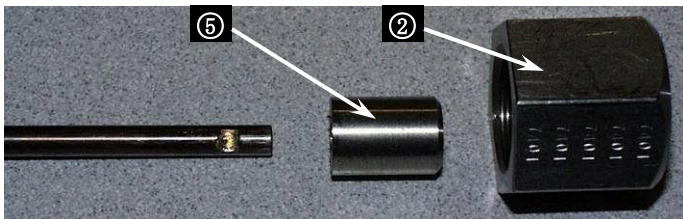

1.0 INTRODUCTION

PGI's Rod-Out Devices feature:

- Power Drill Operation—for Maximum Clean-Out Power and Ease of Operation
- Integrated Bleed Port and Gauge Port
- Rod Out Under Pressure
- Field Adjustable Grafoil or Teflon® Packing
- Insertion Lengths from 4" to 30" (in 1" increments)
- Various Cutter Diameters—.210" or .320" to .600" (in .101" increments)

WARNING! WARNING! WARNING! WARNING! WARNING! WARNING!

OPERATION OF THIS DEVICE WITHOUT FIRST BEING INSTALLED INTO THE

PIPELINE COULD CAUSE SERIOUS INJURY AND/OR DEATH.

NEVER ATTEMPT TO OPERATE THIS DEVICE OUTSIDE OF THE PIPELINE!

2.0 INSTALLATION

- 2.1 Remove the Rod-Out Device from the shipping box and check the body stamping for correct part or identification number.

- 2.2 Prior to installing the Rod-Out Device, check the piping to which it is to be connected for cleanliness and remove any foreign debris.

2.3 Rod-Out Device Installation

- 2.3.1 All pipe or fitting connections must be made tight. NPT pipe joints depend on a good, smooth engagement between the male and female pipe threads, usually with the use of a thread sealant. Typically, Grafoil tape is used in high temperature applications. For low temperature applications, Teflon tape or other standard pipe thread sealants may be used.
- 2.3.2 Check the threads on both the Rod-Out Device and the mating pipe for cleanliness.
- 2.3.3 Do not use excessive wrenching force on an NPT pipe joint. Refer to the chart below for the proper torque for your NPT pipe connection fitting.

PIPE OR TUBE ANSI/ASME B1.20.1 NOMINAL INCH	TIGHTENING TORQUE		
	INCH-POUNDS IN-LBS	FOOT-POUNDS FT-LBS	METER-NEWTONS MN
1/4	600	50	68
3/8	700	58	79
1/2	850	71	96
3/4	1,000	83	113
1	1,200	100	136

3.0 OPERATION

3.1 Rod-Out Devices which have been reasonably matched to a typical service application and properly installed in its piping system can be expected to have a long service life with minimum attention. However, the Rod-Outs have moving and wearing parts and depend on long term preservation of highly finished surfaces on certain working parts for satisfactory performance.

3.2 All threads on your Rod-Out Device are right-hand. Rotate fittings and plugs clockwise to tighten and counter-clockwise to loosen.

Tools Needed: 3/32" Allen Wrench, Hand-Held Drill (with or without Quick-Connect Coupling)

Your Rod-Out Device was designed to be operated with the use of a hand-held drill. The 1/4" Hex Drive connector will accept a standard quick-connect coupling (shown below), providing easy connect/disconnect capability.

If a quick-connect coupling is not available, the connector will also accept a three-jaw drill chuck.

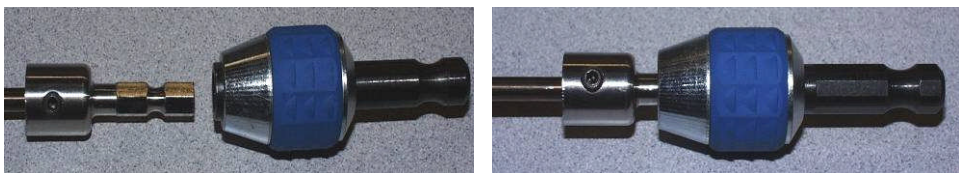

Once the connector is secured in the drill chuck, apply power to the drill and push the Rod into the pipe.

- Do not use excessive force.
- To increase the Packing life, use lower speed/higher torque settings on the drill motor.
- The Cutter should turn clockwise whether pushing or pulling.

4.0 PACKING ADJUSTMENT INSTRUCTIONS

NOTE: Packing adjustments can be performed safely while the Rod-Out Device is under full line pressure. **However, ALL PRESSURE MUST BE REMOVED FROM THE DEVICE PRIOR TO ADDING NEW PACKING.** Refer to Figure 1 for corresponding part names and numbers.

Tools Needed: 1" Open-End Wrench or 8" Adjustable Wrench

The packing in your Rod-Out Device will wear with normal use, resulting in leakage. When leakage occurs, simply tighten the Packing Adjuster in 1/8 turn increments until the leak is corrected and resume normal operation.

When the Packing has depleted to the point that leakage can not be corrected, **all pressure MUST be removed from the unit prior to adding new packing.** The packing is never "replaced," rather new packing is added. See **INSTRUCTIONS FOR ADDING PACKING** in this manual.

