

# NivoGuide® 8200

Two-wire 4 ... 20 mA/HART, with SIL qualification

Coax probe

-196 ... +280 °C, -196 ... +450 °C

TDR sensor for continuous level and interface  
measurement of liquids



---

Quick setup guide



Document ID: 61913



## Contents

|  |           |
|--|-----------|
| <b>1 For your safety .....</b>                               | <b>3</b>  |
| 1.1 Authorised personnel .....                               | 3         |
| 1.2 Appropriate use.....                                     | 3         |
| 1.3 Warning about incorrect use.....                         | 3         |
| 1.4 General safety instructions .....                        | 3         |
| 1.5 EU conformity.....                                       | 4         |
| 1.6 SIL qualification according to IEC 61508.....            | 4         |
| 1.7 NAMUR recommendations .....                              | 4         |
| <b>2 Product description .....</b>                           | <b>5</b>  |
| 2.1 Configuration.....                                       | 5         |
| <b>3 Mounting.....</b>                                       | <b>6</b>  |
| 3.1 General instructions for use of the instrument .....     | 6         |
| 3.2 Mounting instructions .....                              | 6         |
| <b>4 Connecting to power supply.....</b>                     | <b>7</b>  |
| 4.1 Connecting.....  | 7         |
| 4.2 Wiring plan, single chamber housing.....                 | 8         |
| 4.3 Wiring plan, double chamber housing .....                | 8         |
| <b>5 Set up with the display and adjustment module .....</b> | <b>10</b> |
| 5.1 Insert display and adjustment module .....               | 10        |
| 5.2 Parameter adjustment .....                               | 11        |
| <b>6 Supplement .....</b>                                    | <b>13</b> |
| 6.1 Technical data .....                                     | 13        |



### Information:

This quick setup guide enables quick setup and commissioning of your instrument.

You can find supplementary information in the corresponding, more detailed Operating Instructions Manual as well as the Safety Manual that comes with instruments with SIL qualification. These manuals are available on our homepage.

**Operating instructions NivoGuide 8200 - Two-wire 4 ... 20 mA/  
HART - Coaxial probe - With SIL qualification, -196 ... +280 °C /  
-196 ... +450 °C: Document-ID 61902**

Editing status of the quick setup guide: 2019-07-30

## 1 For your safety

### 1.1 Authorised personnel

All operations described in this documentation must be carried out only by trained, qualified personnel authorised by the plant operator.

During work on and with the device, the required personal protective equipment must always be worn.

### 1.2 Appropriate use

NivoGuide 8200 is a sensor for continuous level measurement.

You can find detailed information about the area of application in chapter "*Product description*".

Operational reliability is ensured only if the instrument is properly used according to the specifications in the operating instructions manual as well as possible supplementary instructions.

### 1.3 Warning about incorrect use

Inappropriate or incorrect use of this product can give rise to application-specific hazards, e.g. vessel overflow through incorrect mounting or adjustment. Damage to property and persons or environmental contamination can result. Also, the protective characteristics of the instrument can be impaired.

### 1.4 General safety instructions

This is a state-of-the-art instrument complying with all prevailing regulations and directives. The instrument must only be operated in a technically flawless and reliable condition. The operator is responsible for the trouble-free operation of the instrument. When measuring aggressive or corrosive media that can cause a dangerous situation if the instrument malfunctions, the operator has to implement suitable measures to make sure the instrument is functioning properly.

During the entire duration of use, the user is obliged to determine the compliance of the necessary occupational safety measures with the current valid rules and regulations and also take note of new regulations.

The safety instructions in this operating instructions manual, the national installation standards as well as the valid safety regulations and accident prevention rules must be observed by the user.

For safety and warranty reasons, any invasive work on the device beyond that described in the operating instructions manual may be carried out only by personnel authorised by the manufacturer. Arbitrary conversions or modifications are explicitly forbidden. For safety reasons, only the accessory specified by the manufacturer must be used.

To avoid any danger, the safety approval markings and safety tips on the device must also be observed and their meaning read in this operating instructions manual.

## 1.5 EU conformity

The device fulfils the legal requirements of the applicable EU directives. By affixing the CE marking, we confirm the conformity of the instrument with these directives.

The EU conformity declaration can be found on our homepage.

### Electromagnetic compatibility

Instruments in four-wire or Ex-d-ia version are designed for use in an industrial environment. Nevertheless, electromagnetic interference from electrical conductors and radiated emissions must be taken into account, as is usual with class A instruments according to EN 61326-1. If the instrument is used in a different environment, the electromagnetic compatibility to other instruments must be ensured by suitable measures.

## 1.6 SIL qualification according to IEC 61508

The Safety Integrity Level (SIL) of an electronic system is used to assess the reliability of integrated safety functions.

For detailed specification of the safety requirements, multiple SIL levels are specified according to safety standard IEC 61508. You can find detailed information in chapter "*Functional safety (SIL)*" of the operating instructions.

The instrument meets the specifications of IEC 61508: 2010 (Edition 2). It is qualified for single-channel operation up to SIL2. The instrument can be used homogeneously redundant up to SIL3 in multi-channel architecture with HFT 1.

## 1.7 NAMUR recommendations

NAMUR is the automation technology user association in the process industry in Germany. The published NAMUR recommendations are accepted as the standard in field instrumentation.

The device fulfils the requirements of the following NAMUR recommendations:

- NE 21 – Electromagnetic compatibility of equipment
- NE 43 – Signal level for fault information from measuring transducers
- NE 53 – Compatibility of field devices and display/adjustment components
- NE 107 – Self-monitoring and diagnosis of field devices

For further information see [www.namur.de](http://www.namur.de).

## 2 Product description

### 2.1 Configuration

#### Type label

The type label contains the most important data for identification and use of the instrument:

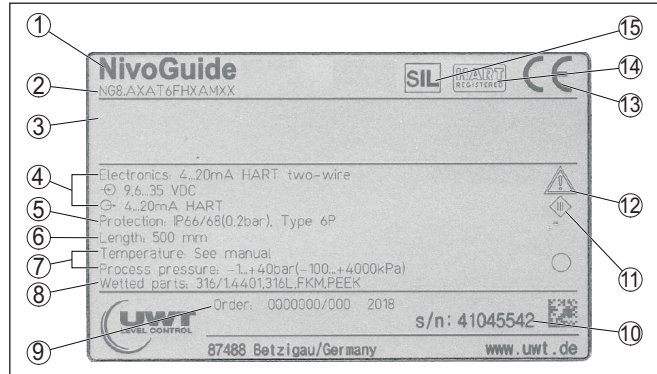

Fig. 1: Layout of the type label (example)

- 1 Instrument type
- 2 Product code
- 3 Approvals
- 4 Power supply and signal output, electronics
- 5 Protection rating
- 6 Probe length (measurement accuracy optional)
- 7 Process and ambient temperature, process pressure
- 8 Material wetted parts
- 9 Order number
- 10 Serial number of the instrument
- 11 Symbol of the device protection class
- 12 Reminder to observe the instrument documentation
- 13 Notified authority for CE marking
- 14 Approval directives
- 15 Marking of the safety function in SIS

### 3 Mounting

#### 3.1 General instructions for use of the instrument

**Protection against moisture**

Protect your instrument against moisture ingress through the following measures:

- Use a suitable connection cable (see chapter "Connecting to power supply")
- Tighten the cable gland or plug connector
- Lead the connection cable downward in front of the cable entry or plug connector

This applies mainly to outdoor installations, in areas where high humidity is expected (e.g. through cleaning processes) and on cooled or heated vessels.



**Note:**

Make sure that the degree of contamination specified in chapter "Technical data" meets the existing ambient conditions.



**Note:**

Make sure that during installation or maintenance no moisture or dirt can get inside the instrument.

To maintain the housing protection, make sure that the housing lid is closed during operation and locked, if necessary.

#### 3.2 Mounting instructions

**Installation position**

In vessels with conical bottom it can be advantageous to mount the sensor in the center of the vessel, as measurement is then possible nearly down to the lowest point of the bottom. Keep in mind that measurement all the way down to the tip of the probe may not be possible. The exact value of the min. distance (lower dead zone) is stated in chapter "Technical data".

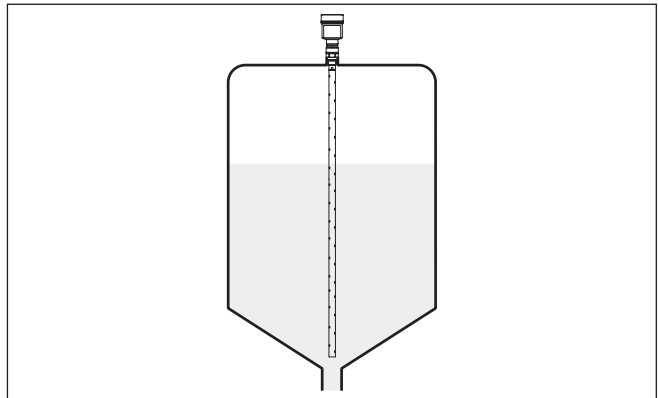

Fig. 2: Vessel with conical bottom

## 4 Connecting to power supply

### 4.1 Connecting

#### Connection technology

The voltage supply and signal output are connected via the spring-loaded terminals in the housing.

Connection to the display and adjustment module or to the interface adapter is carried out via contact pins in the housing.



#### Information:

The terminal block is pluggable and can be removed from the electronics. To do this, lift the terminal block with a small screwdriver and pull it out. When reinserting the terminal block, you should hear it snap in.

#### Connection procedure

Proceed as follows:

1. Unscrew the housing lid
2. If a display and adjustment module is installed, remove it by turning it slightly to the left
3. Loosen compression nut of the cable gland and remove blind plug
4. Remove approx. 10 cm (4 in) of the cable mantle, strip approx. 1 cm (0.4 in) of insulation from the ends of the individual wires
5. Insert the cable into the sensor through the cable entry

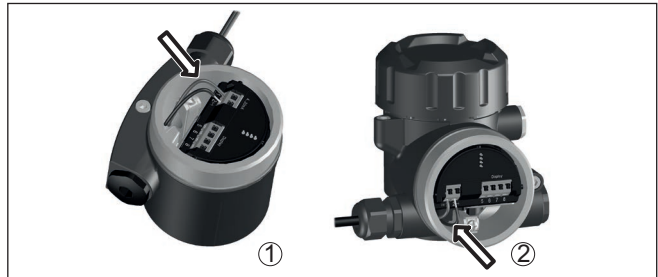

Fig. 3: Connection steps 5 and 6

- 1 Single chamber housing
- 2 Double chamber housing

6. Insert the wire ends into the terminals according to the wiring plan



#### Information:

Solid cores as well as flexible cores with wire end sleeves are inserted directly into the terminal openings. In case of flexible cores without end sleeves, press the terminal from above with a small screwdriver, the terminal opening is then free. When the screwdriver is released, the terminal closes again.

You can find further information on the max. wire cross-section under "*Technical data - Electromechanical data*".

7. Check the hold of the wires in the terminals by lightly pulling on them

8. Connect the screen to the internal ground terminal, connect the external ground terminal to potential equalisation
  9. Tighten the compression nut of the cable entry gland. The seal ring must completely encircle the cable
  10. Reinsert the display and adjustment module, if one was installed
  11. Screw the housing lid back on
- The electrical connection is finished.

## 4.2 Wiring plan, single chamber housing



The following illustration applies to the non-Ex, Ex-ia and Ex-d-ia version.

### Electronics and connection compartment

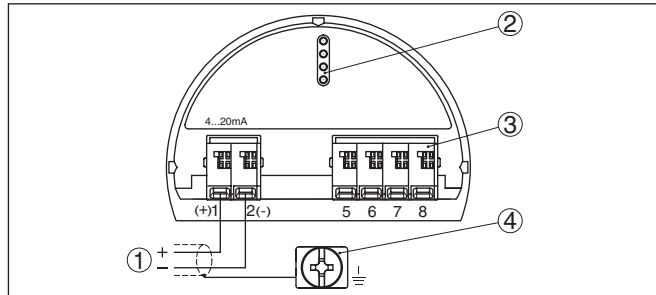

Fig. 4: Electronics and connection compartment - single chamber housing

- 1 Voltage supply, signal output
- 2 For display and adjustment module or interface adapter
- 3 For external display and adjustment unit
- 4 Ground terminal for connection of the cable screening

## 4.3 Wiring plan, double chamber housing



The following illustrations apply to the non-Ex as well as to the Ex-ia version.



Connection compartment

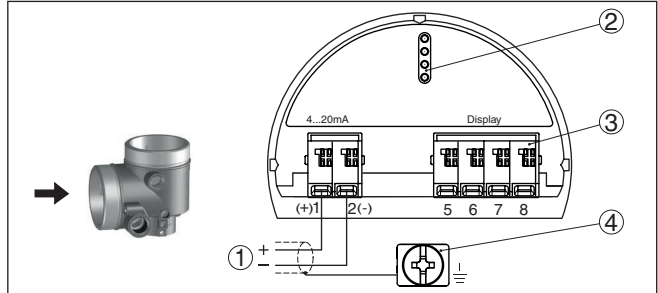

Fig. 5: Connection compartment - double chamber housing

- 1 Voltage supply, signal output
- 2 For display and adjustment module or interface adapter
- 3 For external display and adjustment unit
- 4 Ground terminal for connection of the cable screening

## 5 Set up with the display and adjustment module

### 5.1 Insert display and adjustment module

The display and adjustment module can be inserted into the sensor and removed again at any time. You can choose any one of four different positions - each displaced by 90°. It is not necessary to interrupt the power supply.

Proceed as follows:

1. Unscrew the housing lid
2. Place the display and adjustment module on the electronics in the desired position and turn it to the right until it snaps in.
3. Screw housing lid with inspection window tightly back on

Disassembly is carried out in reverse order.

The display and adjustment module is powered by the sensor, an additional connection is not necessary.



Fig. 6: Installing the display and adjustment module in the electronics compartment of the single chamber housing



Fig. 7: Installing the display and adjustment module in the double chamber housing

- 1 In the electronics compartment
- 2 In the connection compartment



**Note:**

If you intend to retrofit the instrument with a display and adjustment module for continuous measured value indication, a higher lid with an inspection glass is required.

## 5.2 Parameter adjustment

### Set parameters

1. In this menu item you can select the application. You can choose between level and interface measurement.

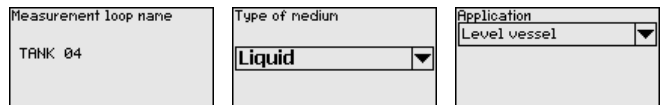

2. In the menu item "Medium - Dielectric constant" you can define the type of medium (medium).
3. Carry out the adjustment in the menu items "Min. adjustment" and "Max. adjustment".

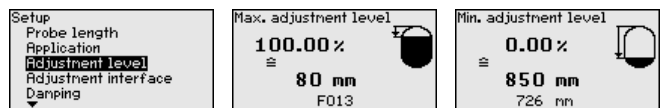

4. A "Linearization" is recommended for all vessels in which the vessel volume does not increase linearly with the level - e.g. in a horizontal cylindrical or spherical tank. Activate the appropriate curve.

5. A "False signal suppression" detects, marks and saves the false signals so that they are no longer taken into account for level measurement. We generally recommend a false signal suppression.

**Parameterization example** The sensor measures the distance from the sensor (reference plane) to the product surface.

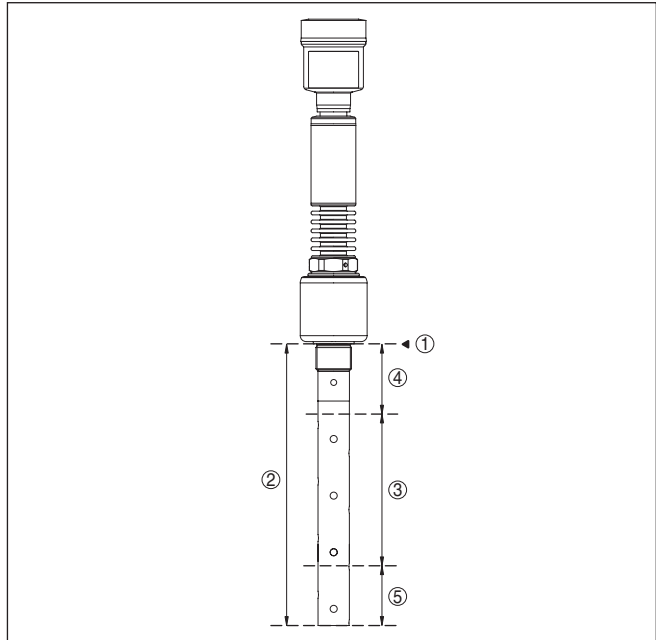

Fig. 8: Measuring ranges - NivoGuide 8200

- 1 Reference plane
- 2 Probe length  $L$
- 3 Measuring range (default setting refers to the measuring range in water)
- 4 Upper dead zone (in this area no measurement is possible)
- 5 Lower dead zone (in this area no measurement is possible)

For this adjustment, the distance is entered when the vessel is full and nearly empty. If these values are not known, an adjustment with other distances, for example, 10 % and 90 % is also possible. Starting point for these distance specifications is always the seal surface of the thread or flange.

### Further steps

1. In the menu "Additional settings", menu item "Damping" you can adjust the requested damping of the output signal.
2. Select the parameter of the current output and the output characteristics in the menu item "Current output".







Printing date:

All statements concerning scope of delivery, application, practical use and operating conditions of the sensors and processing systems correspond to the information available at the time of printing.  
Subject to change without prior notice

**Technical support**

Please contact your local sales partner (address at [www.uwt.de](http://www.uwt.de)). Otherwise please contact us:

UWT GmbH  
Westendstraße 5  
87488 Betzigau  
Germany

Phone +49 831 57123-0  
Fax +49 831 76879  
[info@uwt.de](mailto:info@uwt.de)  
[www.uwt.de](http://www.uwt.de)

61913-EN-190731